



Intelligent IPM

Installation and Operations Manual



Instructions

This symbol is intended to alert the user to the presence of important operating and maintenance (servicing) instructions in the literature accompanying the appliance.



Dangerous Voltage

This symbol is intended to alert the user to the presence of un-insulated dangerous voltage within the product's enclosure that may be of sufficient magnitude to constitute a risk of electric shock to persons.



Protective Grounding Terminal

This symbol indicates a terminal that must be connected to earth ground prior to making any other connections to the equipment.

Life-Support Policy

As a general policy, Server Technology does not recommend the use of any of its products in the following situations:

- life-support applications where failure or malfunction of the Server Technology product can be reasonably expected to cause failure of the life-support device or to significantly affect its safety or effectiveness.
- direct patient care.

Server Technology will not knowingly sell its products for use in such applications unless it receives in writing assurances satisfactory to Server Technology that:

- the risks of injury or damage have been minimized,
- the customer assumes all such risks, and
- the liability of Server Technology is adequately protected under the circumstances.

The term life-support device includes but is not limited to neonatal oxygen analyzers, nerve stimulators (whether used for anesthesia, pain relief or other purposes), auto-transfusion devices, blood pumps, defibrillators, arrhythmia detectors and alarms, pacemakers, hemodialysis systems, peritoneal dialysis systems, neonatal ventilator incubators, ventilators (for adults or infants), anesthesia ventilators, infusion pumps, and any other devices designated as "critical" by the U.S. FDA.

Notices

301-0108-1 Rev. E (011711)

Copyright © 2005-2011 Server Technology, Inc. All rights reserved.

1040 Sandhill Drive

Reno, Nevada 89521 USA

All Rights Reserved

This publication is protected by copyright and all rights are reserved. No part of it may be reproduced or transmitted by any means or in any form, without prior consent in writing from Server Technology.

The information in this document has been carefully checked and is believed to be accurate. However, changes are made periodically. These changes are incorporated in newer publication editions. Server Technology may improve and/or change products described in this publication at any time. Due to continuing system improvements, Server Technology is not responsible for inaccurate information which may appear in this manual. For the latest product updates, consult the Server Technology web site at www.servertech.com. In no event will Server Technology be liable for direct, indirect, special, exemplary, incidental or consequential damages resulting from any defect or omission in this document, even if advised of the possibility of such damages.

In the interest of continued product development, Server Technology reserves the right to make improvements in this document and the products it describes at any time, without notices or obligation.

Sentry, Intelligent IPM, Environmental Monitor and Post-On are trademarks of Server Technology, Inc.

Other trademarks and trade names may be used in this document to refer to either the entities claiming the marks and names or their products. Server Technology, Inc. disclaims any proprietary interest in trademarks and trade names other than its own.



Please Recycle

Shipping materials are recyclable. Please save them for later use, or dispose of them appropriately.

Table of Contents

CHAPTER 1: INTRODUCTION	4
Quick Start Guide.....	4
Technical Support	4
Equipment Overview.....	5
CHAPTER 2: INSTALLATION	6
Standard Accessories.....	6
Optional Accessories.....	6
Safety Precautions	6
Installing the Power Input Retention Bracket.....	7
Connecting to the Power Source	7
Connecting Devices.....	7
Connecting the Sensors	7
Connecting to the Unit	7
CHAPTER 3: OPERATIONS	9
Interfaces	10
HTML Interface	11
Command Line Interface.....	24
CHAPTER 4: ADVANCED OPERATIONS	49
SSL	50
SSH	51
SNMP.....	52
LDAP	59
TACACS+.....	68
Logging	73
Upload/Download	77
CHAPTER 5: APPENDICES	79
Appendix A: Resetting to Factory Defaults	79
Appendix B: Uploading Firmware	79
Appendix C: Technical Specifications	80
Appendix D: Warranty, Product Registration and Support.....	83

Chapter 1: Introduction

Quick Start Guide

The following instructions will help you quickly install and configure your Intelligent IPM for use in your data center equipment cabinet. For detailed information on each step, go to the page number listed to the right.

1. Mount the Intelligent IPM.....6
2. Connect to the power source7
3. Connect the devices.....7
4. Connect the sensors.....7
5. Connect to the Intelligent IPM7
6. Configure the Intelligent IPM9
 - Login as the predefined Administrator (admin/admin)10
 - Configure the network settings14
 - Create new administrative user account.....15
 - Configure location and Intelligent IPM names13
 - Configure sensor names.....14
 - Configure new user account(s)15
 - Remove the predefined Administrator.....16
7. Connect the Intelligent IPM to the network.

Technical Support



Experience Server Technology's **FREE SMARTER Technical Support** - [Learn more...](#)

Server Technology understands that there are often questions when installing and/or using a new product. Free Technical Support is provided from 6:00 AM to 7:00 PM, Monday-Friday, Pacific Time.

Server Technology, Inc.

1040 Sandhill Drive
Reno, Nevada 89521 USA

Tel: 775.284.2000
Fax: 775.284.2065

Web: www.servertech.com
Email: support@servertech.com

Equipment Overview

1. The power inlet/cord(s) connects the Intelligent IPM to the electrical power source.
2. Two RJ45 connectors for Serial (RS-232) and Ethernet connection.
3. Two mini RJ11 connectors for Temperature/Humidity sensors.

A number is printed above each outlet. These numbers may be used in commands that require an outlet name. See *Outlet Naming and Grouping* in Chapter 3: Operations for more information.

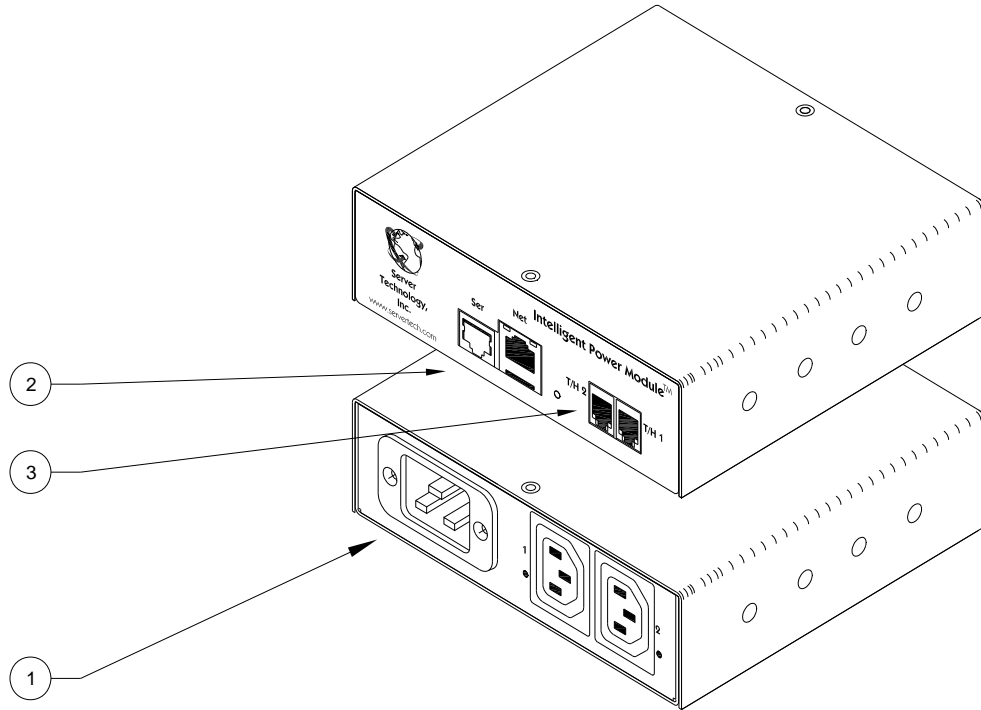

Figure 1. Intelligent IPM Views

Chapter 2: Installation

Before installing your Sentry Intelligent IPM, refer to the following lists to ensure that you have all the items shipped with the unit as well as all other items required for proper installation.

Standard Accessories



- RJ45 to RJ45 crossover cable.
- RJ45 to DB9F serial port adapter (for connection to standard DB9M DTE serial port).
- Outlet retention clips (208-240V models).
- Separate power input cord.
- Power input retention bracket hardware (may be installed):
Two removable T-brackets with two 40mm screws.

Optional Accessories

- Temperature/Humidity sensors
- Rack mounting hardware

Safety Precautions

This section contains important safety and regulatory information that should be reviewed before installing and using the Sentry Intelligent IPM. For input and output current ratings, see *Power Ratings* in Appendix C: Technical Specifications.

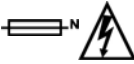
	Only for installation and use in a Service Access Location in accordance with the following installation and use instructions.	<i>Destiné à l'installation et l'utilisation dans le cadre de Service Access Location selon les instructions d'installation et d'utilisation.</i>	Nur für Installation und Gebrauch an Anschlusszugriffspunkten gemäß der folgenden Installations- und Gebrauchsanweisungen.
	This equipment is designed to be installed on a dedicated circuit.	<i>Cet équipement est conçu à être installé sur un circuit spécialisé.</i>	Diese Ausrüstung ist zur Installation in einem festen Stromkreis vorgesehen.
	Dedicated circuit must have circuit breaker or fuse protection. Intelligent IPMs have been designed without a master circuit breaker or fuse to avoid becoming a single point of failure. It is the customer's responsibility to provide adequate protection for the dedicated power circuit. Protection of capacity equal to the current rating of the Intelligent IPM must be provided and must meet all applicable codes and regulations. In North American, protection must have a 10,000A interrupt capacity.	<i>Le circuit spécialisé doit avoir un disjoncteur ou une protection de fusible. Intelligent IPMs ont été conçus sans disjoncteur général ni fusible pour éviter que cela devienne un seul endroit de panne. C'est la responsabilité du client de fournir une protection adéquate pour le circuit-alimentation spécialisé. Protection de capacité équivalente à la puissance de l'équipement, et respectant tous les codes et normes applicables. Les disjoncteurs ou fusibles destinés à l'installation en Amérique du Nord doivent avoir une capacité d'interruption de 10.000 A.</i>	Der feste Stromkreis muss mit einem Schutzschalter oder einem Sicherungsschutz versehen sein. Intelligent IPMs verfügt über keinen Hauptschutzschalter bzw. über keine Sicherung, damit kein einzelner Fehlerpunkt entstehen kann. Der Kunde ist dafür verantwortlich, den Stromkreis sachgemäß zu schützen. Der Kapazitätsschutz entspricht der aktuellen Stromstärke der Geräte und muss alle relevanten Codes und Bestimmungen erfüllen. Für Installation in Nordamerika müssen Ausschalter bzw. Sicherung über 10.000 A Unterbrechungskapazität verfügen.
	The plug on the power supply cord shall be installed near the equipment and shall be easily accessible.	<i>La prise sur le cordon d'alimentation sera installée près de l'équipement et sera facilement disponible.</i>	Der Stecker des Netzkabels muss in der Nähe der Ausrüstung installiert werden und leicht zugänglich sein.
	Always disconnect the power supply cord before opening to avoid electrical shock.	<i>Toujours déconnecter le cordon d'alimentation avant d'ouvrir pour éviter un choc électrique.</i>	Ziehen Sie vor dem Öffnen immer das Netzkabel heraus, um die Gefahr eines elektrischen Schlags zu vermeiden.
	WARNING! High leakage current! Earth connection is essential before connecting supply!	<i>ATTENTION! Haut fuite très possible! Une connection de masse est essentielle avant de connecter l'alimentation!</i>	ACHTUNG! Hoher Ableitstrom! Ein Erdungsanschluss ist vor dem Einschalten der Stromzufuhr erforderlich!
	WARNING! Cx-xxxE-x units Double Pole/Neutral Fusing	<i>ATTENTION! Les unités Cx-xxxE-x Double Pôle/Fusible sur le Neutre</i>	ACHTUNG!: Cx-xxxE-x Zweipolige bzw. Neutralleiter-Sicherung

Installing the Power Input Retention Bracket

To install the power input retention bracket:

1. Remove the two screws attaching the IEC 60320 C19 inlet to the enclosure.
2. Assemble and attach the retention bracket to the enclosure as shown.

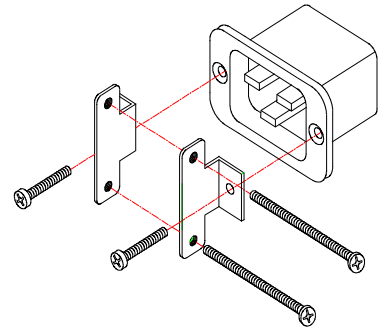

Figure 2.1 Retention Bracket assembly

Connecting to the Power Source

To attach a power cord to the unit:

1. Plug the female end of the power cord firmly into its connector at the base.
2. Use a screwdriver to tighten the two screws on the retention bracket.

To connect to the power source:

Plug the male end of the power cord into the AC power source.

Connecting Devices

1. Keep the device's on/off switch in the off position until after it is plugged into the outlet.
2. Connect devices to the Intelligent IPM outlets.

NOTE: Server Technology recommends even distribution of attached devices across all available outlets to avoid exceeding the outlet, branch or phase limitations. See *Power Ratings* on page 80 for more information.



Always disconnect ALL power supply cords before opening to avoid electrical shock.

Afin d'éviter les chocs électriques, débranchez TOUTES les câbles électrique avant d'ouvrir.

Immer ALLE Netzleitungen auskuppeln vor den Aufmachen um elektrischen Schlag zu vermeiden.

Connecting the Sensors

The Intelligent IPM is equipped with two mini RJ11 T/H ports for attachment of the Temperature/Humidity sensors. Attach the mini RJ11 plug of the sensor(s) to the appropriate T/H port.

Connecting to the Unit

Serial (RS232) port

The Intelligent IPM is equipped with an RJ45 Serial RS-232 port for attachment to a PC or networked terminal server using the supplied RJ45 to RJ45 crossover cable and RJ45 to DB9F serial port adapter as required. See *Data Connections* in Appendix C: Technical Specifications for more information on the Serial RS-232 port.

Ethernet port

The Intelligent IPM is equipped with an RJ45 10/100Base-T Ethernet port for attachment to an existing network. This connection allows access to the Intelligent IPM via Telnet or HTML.

The Intelligent IPM is configured with the following network defaults to allow unit configuration out-of-the-box through either Telnet or HTML:

- IP address: 192.168.1.254
- Subnet Mask: 255.255.255.0
- Gateway: 192.168.1.1

The local PC network connection must be configured as noted below:

NOTE: Contact your system administrator for instructions in reconfiguring the network connection. Reconfiguration of your network connection may require a restart to take effect.

- IP address: 192.168.1.x (where x is 2-253)
- Subnet Mask: 255.255.255.0

Chapter 3: Operations

INTERFACES	10
Outlet Naming and Grouping	10
Usernames and Passwords	10
HTML INTERFACE	11
Logging In	11
Outlet Control	12
<i>Individual</i>	12
<i>Group</i>	12
Environmental Monitoring	13
<i>Sensors</i>	13
Configuration	13
<i>System</i>	13
<i>Network</i>	14
<i>Telnet/SSH</i>	14
<i>HTTP/SSL</i>	15
<i>Serial Ports</i>	15
<i>Outlets</i>	16
<i>Groups</i>	16
<i>Users</i>	16
<i>FTP</i>	18
<i>SNTP/Syslog</i>	18
<i>SNMP</i>	19
<i>LDAP</i>	20
<i>TACACS+</i>	21
<i>Email</i>	22
Tools	23
<i>Restart</i>	23
<i>Ping</i>	23
<i>Change Password</i>	23
<i>View Log</i>	23
COMMAND LINE INTERFACE	24
Logging In	24
Operations Commands	27
Administration Commands	31
<i>User Administration</i>	31
<i>Outlet Administration</i>	34
<i>Group Administration</i>	36
<i>Environmental Monitor Administration</i>	37
<i>Serial Port Administration</i>	37
<i>System Administration</i>	38
<i>TCP/IP Administration</i>	42
<i>HTTP Administration</i>	43
<i>Telnet Administration</i>	44
<i>FTP Administration</i>	44
<i>SNTP Administration</i>	46

Interfaces

The Intelligent IPM has two interfaces: the HTML interface accessed via the HTTP enabled Ethernet connections, and the command line for serial and Telnet connections.

Outlet Naming and Grouping

For commands requiring an outlet name, you may specify it in one of two ways: a predefined absolute name or a descriptive name assigned by an administrator.

Absolute names are specified by a period (.) followed by a tower letter and outlet number. The tower letter for the Intelligent IPM is A.

Outlets may also be included in one or more named groups of outlets, enabling you to issue a command that affects all outlets in a named group.

Usernames and Passwords

The Intelligent IPM has one predefined administrative user account (username/password: admn/admn), and supports a maximum of 128 defined user accounts.

NOTE: For security, Server Technology recommends removal of the predefined administrative user account after a new account with administrative rights has been created.

Only an administrative-level user may perform operations such as creating/removing user accounts and command privileges, changing passwords and displaying user information. An administrator may also view the status of all sensors and power inputs.

Usernames may contain from 1-16 characters and are not case sensitive; spaces are not allowed. Passwords may contain up to 16 characters, and are case sensitive.

HTML Interface

The HTML interface is constructed of three major components: the System Location bar, the User/Navigation bar and the Control Screen. The System Location bar displays the Sentry's location and IP address as well as the current Control Screen title. The User/Navigation bar displays the current user and privilege level and provides access to all HTML pages. The Control Screen is used to display current data and allow changes to outlet states or system configuration.

The following sections describe each interface section/page and their use.

The screenshot shows the Sentry Power Distribution Unit interface in a Microsoft Internet Explorer browser window. The browser title is 'Sentry Power Distribution Unit - Microsoft Internet Explorer' and the address bar shows 'http://64.42.31.200/'. The interface features a blue header with the Sentry logo and 'Power Distribution Unit' text. Below the header, a dark blue bar displays the IP address '64.42.31.200' and the page title 'Environmental Monitoring - Input Feeds'. The main content area is titled 'Input Feeds' and contains a table with the following data:

Input Feed ID	Input Feed Name	Input Status	Input Load
AA	TowerA_InfeedA	On	0.00 Amps
AB	TowerA_InfeedB	On	0.00 Amps
AC	TowerA_InfeedC	On	0.00 Amps
BA	TowerB_InfeedA	On	0.00 Amps
BB	TowerB_InfeedB	On	0.00 Amps
BC	TowerB_InfeedC	On	0.25 Amps

Arrows from the labels 'User/Navigation', 'System Location', and 'Control Screen' point to their respective sections in the interface.

Figure 3.1 Example HTML page

Logging In

Logging in through HTML requires directing the HTML client to the configured IP address of the unit.

To log in by HTML:

In the login window, enter a valid username and password and press **OK**.

If you enter an invalid username or password, you will be prompted again.

You are given three attempts to enter a valid username and password combination. If all three fail, the session ends and a protected page will be displayed.

NOTE: The default Sentry username/password is `admn/admn`.

Outlet Control

The Outlet Control section offers access to the Individual and Group outlet control pages. From the Individual and Group pages, the user can review and manipulate power control functions for all outlets and groups assigned to the current user. Both pages include the outlet's absolute and descriptive names, the Outlet Status reported to the Sentry by the outlet, the current Control State being applied by the Sentry, and the outlet load in amperes.

Available outlet and group power states may be set to on, off or reboot.

Individual

The Individual outlet control page displays all outlets assigned to the current user. The user may apply on, off or reboot actions to individual, multiple or all accessible outlets.

To apply actions to individual or multiple outlets:

In the Individual Outlet Control section, select the desired action from the Control Action drop-down menu for each individual outlet to be changed, and press **Apply**.

To apply an action to all outlets:

In the Global Control section, select the desired action from the Control Action drop-down menu and press **Apply**.

Group

The Group outlet control page displays all groups assigned to the current user, as well as the outlets for each group.

To select a group:

Select the group name from the drop-down menu and press **Select**. The page will refresh to display all outlets associated to the selected group name.

To apply an action to a group:

Select the desired action from the drop-down menu and press **Apply**.

Outlet State/Control State Field Values

Outlet State	Control State	Description
On	On	Outlet is on
Off	Off	Outlet is off
Off	Pend On	Outlet is off and about to turn on in response to a sequence timer
Off	Reboot	Outlet is off and a Reboot action has been initiated
On	Idle On	A restart has occurred – Last Control State has been maintained
Off	Idle Off	A restart has occurred – Last Control State has been maintained
On	Wake On	A power-loss has occurred – Wakeup State has been applied
Off	Wake Off	A power-loss has occurred – Wakeup State has been applied
On/Wait	Off	Outlet state in transition – Requery of outlet status required
Off/Wait	On	Outlet state in transition – Requery of outlet status required
On/Error	varies	Error State – Outlet should be off, but current is sensed at the outlet
Off/Error	varies	Error State – Outlet should be on, but no current is sensed at the outlet
Off/Fuse	On	Outlet should be on, but a blown fuse has been detected
No Comm	varies	Communication to the outlet has been lost*

* Control State will be applied when communication is re-established

Environmental Monitoring

Sensors

The Sensors page displays:

- Temperature/humidity sensor's absolute and descriptive names
- Temperature/humidity sensor readings in degrees Celsius and percent relative humidity

Configuration

The Configuration section offers access to all unit configuration options. This section is available to administrative level users only.

System

The System configuration page is used for reference of system information such as Ethernet NIC Serial Number, Ethernet MAC address and system firmware and hardware revisions as well as assignment and maintenance of other system wide configurations.

For descriptive names, up to 24 alphanumeric and other typeable characters (ASCII 33 to 126 decimal) are allowed. Spaces are not allowed.

NOTE: Spaces may be used for the location description only.

Creating a pre-login banner:

Click on the **Login Banner** link.

On the subsequent Login Banner page, enter a pre-login banner and press **Apply**.

NOTE: The pre-login banner may be up to 2070 characters in length and is displayed prior to the login prompt. If left blank, no system banner will be displayed prior to login prompt.

Creating a descriptive system location name:

Enter a descriptive name and press **Apply**.

Enabling or disabling strong password requirements:

Sentry supports enforcement of strong passwords for enhanced security. When enabled, all new passwords must be a minimum of 8 characters in length with at least one uppercase letter, one lowercase letter, one number and one special character.

Acceptable strong passwords:

```
n0t0nmyw@tch  
john2STI?  
H3reUgo!
```

NOTE: Strong password requirements also enforce a minimum change of four character positions when defining new strong passwords.

Select **Enabled** or **Disabled** from the Strong Passwords drop-down menu and press **Apply**.

NOTE: The strong password requirement is applied against all new passwords.

Enabling or disabling the external reset button:

Select **Enabled** or **Disabled** from the External Reset Button drop-down menu and press **Apply**.

Setting the temperature scale:

Select **Celsius** or **Fahrenheit** from the Temperature Scale drop-down menu and press **Apply**.

Creating a descriptive unit name:

Click on the **Tower Names** link.

On the subsequent Tower Names page, enter a descriptive name and press **Apply**.

Creating a descriptive input feed name:

Click on the **Input Feed Names** link.

On the subsequent Input Feed Names page, enter a descriptive name and press **Apply**.

Creating a descriptive outlet name:

Click on the **Outlet Names** link which will open the Outlets configuration page. See Outlets on page 16 for additional information on creating descriptive outlet names.

Creating a descriptive serial port name:

Click on the **Serial Port Names** link which will open the Serial Ports configuration page. See *Serial Ports* on page 15 for additional information on creating descriptive serial port names.

Creating a descriptive Environmental Monitor name:

Click on the **Environmental Monitor Names** link.

On the subsequent Environmental Monitor Names page, enter a descriptive name and press **Apply**.

Creating descriptive sensor names:

Click on the **Sensor Names** link.

On the subsequent Sensor Names page, enter a descriptive name and press **Apply**.

Network

The Network configuration page is used for maintenance of the network interface. From this page an administrator may configure the IP address, subnet mask, gateway address, DNS addresses as well as view the link status, speed and duplex value.

The Sentry is configured with the following network defaults to allow unit configuration out-of-the-box through either Telnet or HTML:

- IP address: 192.168.1.254
- Subnet Mask: 255.255.255.0
- Gateway: 192.168.1.1

The initial local PC network connection must be configured as noted below:

NOTE: Contact your system administrator for instructions in reconfiguring the network connection. Reconfiguration of your network connection may require a restart to take effect.

- IP address: 192.168.1.x (where x is 2-253)
- Subnet Mask: 255.255.255.0

NOTE: The unit must be restarted after network configuration changes. See *Performing a warm boot:* on page 23.

Enabling or disabling DHCP support:

Select **Enabled** or **Disabled** from the DHCP drop-down menu and press **Apply**.

Setting the IP address, subnet mask, gateway or DNS address:

In the appropriate field, enter the IP address, subnet mask, gateway address or DNS address and press **Apply**.

Telnet/SSH

The Telnet/SSH configuration page used to enable or disable Telnet and SSH support and configure the port number that the Telnet or SSH server watches. For more information on SSH see page 51 in Chapter 4: Advanced Operations.

Enabling or disabling Telnet or SSH support:

Select **Enabled** or **Disabled** from the appropriate Server drop-down menu and press **Apply**.

Changing the Telnet or SSH server port number:

In the appropriate Port field, enter the port number and press **Apply**.

HTTP/SSL

The HTTP/SSL configuration page used to enable or disable HTTP and SSL support, configure the port number that the HTTP server watches and responds to, selection of the method of authentication used and SSL access level. For more information on SSL see page 49 in Chapter 4: Advanced Operations.

Enabling or disabling HTTP or SSL support:

Select **Enabled** or **Disabled** from the appropriate Server drop-down menu and press **Apply**.

Changing the HTTP server port number:

In the HTTP Port field, enter the port number and press **Apply**.

Setting the HTTP authentication method:

The Sentry HTTP server supports two authentication methods for security and validation of the username-password – Basic and MD5 digest.

The Basic method utilizes Base64 encoding to encode and deliver the username-password over the network to the HTTP server for decoding and authentication. This basic method is supported by all web browsers and offers a minimum level of security.

NOTE: The Base64 algorithm is widely-known and susceptible to packet-sniffer attack for acquisition of the encoded username-password string.

The MD5 digest method provides stronger protection utilizing one-way encoded hash numbers, never placing the username-password on the network. Instead, the sending browser creates a challenge code based on the hash algorithm, provided username-password and unique items such as the device IP address and timestamp, which is compared against the HTTP server internal user database of valid challenge codes. The MD5 digest method offers a higher level of security than the Basic method but at present is not supported by all browsers.

NOTE: MD5 is known to be fully supported by Internet Explorer 5.0+

Select **Basic** or **MD5** from the Authentication drop-down menu and press **Apply**.

Setting SSL access level:

Sentry SSL supports configuration of SSL connections as being either optional or required. The default access level is set to optional.

- Optional –Both non-secure (HTTP) and SSL encrypted connections (HTTPS) are allowed access.
- Required – ONLY SSL encrypted connections (HTTPS) are allowed access.

Select **Optional** or **Required** from the Secure Access drop-down menu and press **Apply**.

Serial Ports

The Serial Ports configuration page is used for maintenance of the serial port.

NOTE: Pass-Thru connections may only be initiated from the command line interface via a Telnet/SSH session.

Setting the data-rate for all serial ports:

Select the serial port data-rate from the drop-down menu and press **Apply**.

Setting the serial port timeout value:

Enter the timeout value (in minutes) in the Connection Timeout field and press **Apply**.

Creating a descriptive serial port name:

Click on the **Edit** link in the Action column next to the port to be configured.

On the subsequent Serial Port Edit page, enter a descriptive name. Up to 24 alphanumeric and other typeable characters (ASCII 33 to 126 decimal) are allowed; spaces are not allowed. Press **Apply**.

Enabling or disabling serial port active signal checking:

Click on the **Edit** link in the Action column next to the port to be configured.

On the subsequent Serial Port Edit page, select **On** or **Off** from the DSR Check drop-down menu and press **Apply**.

Outlets

The Outlets configuration page is used for assignment and/or editing of outlet sequence and reboot timers, descriptive names and wakeup states.

Setting the outlet sequencing interval:

Enter the sequencing interval (in seconds) in the Sequence Interval field and press **Apply**.

Setting the outlet reboot delay:

Enter the reboot interval (in seconds) in the Reboot Delay field and press **Apply**.

Editing the outlet descriptive name:

Click on the **Edit** link in the Action column next to the outlet to be configured.

On the subsequent Outlet Edit page, enter a descriptive name. Up to 24 alphanumeric and other typeable characters (ASCII 33 to 126 decimal) are allowed; spaces are not allowed. Press **Apply**.

Changing the outlet wakeup state:

Click on the **Edit** link in the Action column next to the outlet to be configured.

On the subsequent Outlet Edit page, select **On**, **Off** or **Last** from the Wakeup State drop-down menu and press **Apply**.

Setting the outlet Post-On delay:

Click on the **Edit** link in the Action column next to the outlet to be configured.

On the subsequent Outlet Edit page, enter the outlet Post-On delay (in seconds) in the Post-On Delay field and press **Apply**.

Groups

The Groups configuration page is used for creation and deletion of group and assignment of outlets to groups.

Creating a group:

Enter a descriptive group name in the Group Name field. Up to 24 alphanumeric and other typeable characters (ASCII 33 to 126 decimal) are allowed; spaces are not allowed. Press **Apply**.

Removing a group:

Click on the **Remove** link in the Action column for the group to be removed and press **Yes** on the subsequent confirmation window.

Adding and Deleting outlets from a group:

Press the **Edit** link in the Action column for the associated group.

On the subsequent Group Edit page, select or deselect outlets to be included in that group. Press **Apply**.

Users

The Users configuration page is used for creation and removal of usernames, assignment of accessible outlets and group, assignment of privilege levels and the changing of user passwords.

Creating a new user:

Enter a user name in the Username field. Up to 16 alphanumeric and other typeable characters (ASCII 33 to 126 decimal) are allowed; spaces are not allowed.

Enter a password for the new user and verify in the Password and Verify Password fields. For security, password characters are not displayed. Press **Apply**.

Removing a user:

Click on the **Remove** link in the Action column for the user to be removed and press **Yes** on the subsequent confirmation window.

Changing a user password:

Click on the **Edit** link in the Action column for the associated user.

On the subsequent User Edit page, enter a password and verify the new password for the new user in the Password and Verify Password fields. For security, password characters are not displayed. Press **Apply**.

Changing a user's access privilege level:

The Sentry has the following defined privilege levels:

- **Admin:** Full-access for all configuration, control (On, Off, Reboot), status and serial/Pass-Thru ports.
- **Power User:** Full-access for all control (On, Off, Reboot), status and serial/Pass-Thru ports.
- **User:** Partial-access for control (On, Off, Reboot), status and Pass-Thru of assigned outlets, groups and serial/Pass-Thru ports.
- **Reboot-Only:** Partial-access for control (Reboot), status and Pass-Thru of assigned outlets, groups and serial/Pass-Thru ports.
- **On-Only:** Partial-access for control (On), status and Pass-Thru of assigned outlets, groups and serial/Pass-Thru ports.
- **View-Only:** Partial-access for status and Pass-Thru of assigned outlets, groups and serial/Pass-Thru ports.

The administrator may also grant administrative privileges to other user accounts allowing the Sentry to have more than one administrative-level user.

NOTE: You cannot remove administrative privileges from the Admn user unless another user has already been given administrative access level privileges created.

Click on the **Edit** link in the Action column for the associated user.

On the subsequent User Edit page, select **Admin**, **Power-User**, **User**, **Reboot-only**, **On-only** or **View-only** from the Access Level drop-down menu and press **Apply**.

Granting or removing Environmental Monitoring viewing privileges:

Click on the **Edit** link in the Action column for the associated user.

On the subsequent User Edit page, select **Yes** or **No** from the Environmental Monitoring drop-down menu and press **Apply**.

Adding and Deleting outlet access:

Click on the **Outlets** link in the Access column for the associated user.

On the subsequent User Outlets page, select or deselect outlets to be accessed by the user and press **Apply**.

Adding and Deleting group access:

Click on the **Groups** link in the Access column for the associated user.

On the subsequent User Groups page, select or deselect group to be accessed by the user and press **Apply**.

Adding and Deleting serial port access:

Click on the **Ports** link in the Access column for the associated user.

On the subsequent User Ports page, select or deselect ports to be accessed by the user and press **Apply**.

FTP

The FTP configuration page is used for setup and maintenance of all settings required to perform an FTP firmware upload, configure automatic FTP updates or system configuration uploads/downloads.

See Appendix B: Uploading Firmware for more information on uploading firmware.

Setting the FTP Host Address:

Enter the IP address or hostname in the Host field and press **Apply**.

Setting the FTP username:

Enter the FTP server username in the Username field, and press **Apply**.

Setting the FTP password:

Enter the FTP server password in the Password field, and press **Apply**.

Setting the filepath:

Enter the path of the file to be uploaded in the Directory field, and press **Apply**.

Setting the filename for upload:

Enter the filename of the file to be uploaded in the Filename field, and press **Apply**.

Testing the FTP upload configuration:

This test validates that the unit is able to contact and log onto the specified FTP server, download the firmware file and verify that the firmware file is valid for this unit.

Press **Test**.

Enabling or disabling automatic updates:

The Sentry features the ability to schedule automatic firmware updates. When enabled and configured, the Sentry will regularly check the FTP server for a new firmware image and upload it.

Select **Enabled** or **Disabled** from the drop-down menu and press **Apply**.

Setting the automatic update scheduled day:

Select the desired day for the automatic update from the drop-down menu and press **Apply**.

Setting the automatic update scheduled hour:

Select the desired hour for the automatic update from the drop-down menu and press **Apply**.

Enabling or disabling the FTP server:

The Sentry features the ability to upload and download system configuration files to ease implementation across multiple Sentry devices. See Chapter 4: Advanced Operations - Upload/Download for more information on configuration upload and download.

Select **Enabled** or **Disabled** from the drop-down menu and press **Apply**.

NOTE: The FTP server must be enabled for configuration upload or download.

SNTP/Syslog

The SNTP/Syslog configuration page is used for setup and maintenance of SNTP and Syslog support. For additional information and configuration requirements for Syslog support, see Logging on page 73.

Setting the SNTP server address:

Enter the IP address or hostname in the Primary and/or Secondary Host field and press **Apply**.

Setting the Local GMT offset:

Select the local offset from GMT value from the drop-down menu and press **Apply**.

Setting the Syslog server address:

Enter the IP address or hostname in the Primary and/or Secondary Host field and press **Apply**.

Changing the Syslog server port number:

In the Syslog Port field, enter the port number and press **Apply**.

SNMP

The SNMP configuration page is used for setup and maintenance of all settings required to enable SNMP support as well as access to the trap configuration pages. For additional information on SNMP support and detailed descriptions of available traps, see *SNMP* on page 52.

NOTE: Traps are generated according to a hierarchical architecture; i.e. if a Tower Status enters a trap condition, only the Tower Status trap is generated. Infeed and Outlet Status traps are suppressed until the Tower Status returns to Normal.

Enabling or disabling SNMP support:

Select **Enabled** or **Disabled** from the drop-down menu and press **Apply**.

Setting the community strings:

Enter the community string in the appropriate field and press **Apply**.
Community strings may be 1 to 24 characters

Setting the trap timer:

Enter a trap timer value in the Error Trap Repeat Time field and press **Apply**.
The Error Trap Repeat Time value may be 1 to 65535 (in seconds).

Setting trap destinations:

Enter an IP address or hostname in the appropriate Trap Destination field and press **Apply**.

Setting IP Restrictions:

Select **No Restrictions** or **Trap Destinations Only** from the IP Restrictions drop-down menu and press **Apply**.

NOTE: When **Trap Destinations Only** is selected, SNMP Manager GET and SET requests are only allowed from the IP addresses of the defined traps destinations.

Setting the SNMP SysName, SysLocation or SysContact objects:

In the appropriate field, enter the SysName, SysLocation or SysContact objects and press **Apply**.

Enabling or disabling tower traps:

Click on the **Tower Traps** link.

On the subsequent Tower Traps page, select or deselect the desired traps and press **Apply**.

Configuring input feed traps:

Click on the **Input Feed Traps** link.

On the subsequent Input Feed Traps page, select or deselect the desired traps and press **Apply**.

For Load traps, enter a maximum load value for the infeed in the High Load Threshold field and press **Apply**.
The High Load Threshold value may be 0 to 255 (in amperes).

Enabling or disabling Environmental Monitor traps:

Click on the **Environmental Monitor Traps** link.

On the subsequent page, select or deselect the desired traps and press **Apply**.

Configuring the Temperature-Humidity sensor traps:

Click on the **Sensor Traps** link.

On the subsequent page, select or deselect the desired traps and press **Apply**.

For Temp traps, enter a minimum and maximum threshold value for the sensor in the appropriate field and press **Apply**.

The threshold value may be 0 to 127 in degrees Celsius OR 32 to 254 in degrees Fahrenheit.

For Humid traps, enter a minimum and maximum threshold value for the sensor in the appropriate field and press **Apply**.

The threshold value may be 0 to 100 (in percent relative humidity).

Configuring outlet traps:

Click on the **Outlet Traps** link.

On the subsequent Outlet Traps page, select or deselect the desired traps and press **Apply**.

LDAP

The LDAP configuration page is used for setup and maintenance of all settings required to enable LDAP support. For additional information and configuration requirements, see *LDAP* on page 59.

Enabling or disabling LDAP support:

Select **Enabled** or **Disabled** from the LDAP drop-down menu and press **Apply**.

Changing the LDAP server port:

Enter the port number in the LDAP Port field and press **Apply**.

Setting the LDAP server address:

Enter the IP address or hostname in the Primary and/or Secondary Host field and press **Apply**.

Enabling or disabling LDAP over TLS/SSL:

Select **Yes** or **No** from the Use TLS/SSL drop-down menu and press **Apply**.

NOTE: When LDAP over TLS/SSL is enabled, MD5 binding is disabled.

Setting the LDAP bind password type:

Select **Simple** or **MD5** from the Bind Type drop-down menu and press **Apply**.

NOTE: If MD5 binding is enabled, LDAP over TLS/SSL is disabled.

For more information on LDAP bind password types, see *Setting the LDAP bind password type* on page 60.

Setting the search bind Distinguished Name (DN):

Enter the fully-qualified distinguished name (FQDN) in the Search Bind field and press **Apply**.

Setting the search bind password for Distinguished Name (DN):

Enter the Search Bind Password in the Search Bind Password field and press **Apply**.

Setting the user search base Distinguished Name (DN):

Enter the User Search Base DN in the User Search Base DN field and press **Apply**.

Setting the user search filter:

Enter the User Search Filter in the User Search Filter field and press **Apply**.

Setting the group membership attribute:

Enter the group membership attribute in the Group Membership Attribute Field and press **Apply**.

Setting the group membership value type:

Select the appropriate value from the drop-down menu and press **Apply**.

Configuring the authentication order:

Select **Remote -> Local** or **Remote Only** from the drop-down menu and press **Apply**.

For more information on remote authentication order, see *Setting the authentication order* on page 62.

NOTE: Server Technology recommends NOT setting the authentication order to Remote Only until LDAP has been fully configured and tested.

Setting the DNS IP address:

See *Network* on page 14 for information on how to set the DNS IP address.

Configuring LDAP groups:

Click on the **LDAP Groups** link at the bottom of the page.

Creating an LDAP group:

Enter a descriptive group name in the LDAP Group Name field. Up to 24 alphanumeric and other typeable characters (ASCII 33 to 126 decimal) are allowed; spaces are not allowed. Press **Apply**.

Removing an LDAP group:

Click on the **Remove** link in the Action column for the group to be removed and press **OK** on the subsequent confirmation window.

Changing an LDAP group's access privilege level:

Click on the **Edit** link in the Action column for the associated LDAP Group.

On the subsequent LDAP Group - Edit page, select **Admin**, **User**, **On-only** or **View-only** from the Access Level drop-down menu and press **Apply**.

For more information on access privilege levels, see *Changing a user's access privilege level:* on page 17.

Granting or removing Environmental Monitoring viewing privileges:

Click on the **Edit** link in the Action column for the associated LDAP Group.

On the subsequent LDAP Group - Edit page, select **Yes** or **No** from the Environmental Monitoring drop-down menu and press **Apply**.

Adding and Deleting outlet access:

Click on the **Outlets** link in the Access column for the associated LDAP Group.

On the subsequent LDAP Group - Outlets page, select or deselect outlets to be accessed by the LDAP Group and press **Apply**.

Adding and Deleting outlet group access:

Click on the **Groups** link in the Access column for the associated LDAP Group.

On the subsequent LDAP Group - Groups page, select or deselect outlet groups to be accessed by the LDAP Group and press **Apply**.

Adding and Deleting serial port access:

Click on the **Ports** link in the Access column for the associated LDAP Group.

On the subsequent LDAP Group - Ports page, select or deselect ports to be accessed by the LDAP Group and press **Apply**.

TACACS+

The TACACS+ configuration page is used for setup and maintenance of all settings required to enable TACACS+ support. For additional information and configuration requirements, see *TACACS+* on page 68.

Enabling or disabling TACACS+ support:

Select **Enabled** or **Disabled** from the TACACS+ drop-down menu and press **Apply**.

Changing the TACACS+ server port:

Enter the port number in the Port field and press **Apply**.

Setting the TACACS+ server address:

Enter the IP address or hostname in the Primary and/or Secondary Host field and press **Apply**.

Configuring the authentication order:

Select **Remote** -> **Local** or **Remote Only** from the drop-down menu and press **Apply**.

For more information on remote authentication order, see *Setting the authentication order:* on page 69.

NOTE: Server Technology recommends NOT setting the authentication order to Remote Only until TACACS has been fully configured and tested.

Setting the TACACS+ encryption key:

Enter a key and verify the new key the Encryption Key and Verify Encryption Key fields. Press **Apply**.

For security, key characters are not displayed.

Configuring TACACS+ privilege levels:

Click on the **TACACS+ Privilege Levels** link at the bottom of the page.

Changing an TACACS+ Privilege Level's access privilege level:

Click on the **Edit** link in the Action column for the associated TACACS+ Privilege Level.

On the subsequent TACACS+ Privilege Level - Edit page, select **Admin**, **User**, **On-only** or **View-only** from the Access Level drop-down menu and press **Apply**.

For more information on access levels, see *Changing a user's access privilege level:* on page 17.

Granting or removing Environmental Monitoring viewing privileges:

Click on the **Edit** link in the Action column for the associated TACACS+ privilege level.

On the subsequent TACACS+ Privilege Level - Edit page, select **Yes** or **No** from the Environmental Monitoring drop-down menu and press **Apply**.

Adding and Deleting outlet access:

Click on the **Outlets** link in the Access column for the associated TACACS+ Privilege Level.

On the subsequent LDAP Group - Outlets page, select or deselect outlets to be accessed by the TACACS+ Privilege Level and press **Apply**.

Adding and Deleting outlet group access:

Click on the **Groups** link in the Access column for the associated TACACS+ Privilege Level.

On the subsequent LDAP Group - Groups page, select or deselect outlet groups to be accessed by the TACACS+ Privilege Level and press **Apply**.

Adding and Deleting serial port access:

Click on the **Ports** link in the Access column for the associated TACACS+ Privilege Level.

On the subsequent LDAP Group - Ports page, select or deselect ports to be accessed by the TACACS+ Privilege Level and press **Apply**.

Email

The Email configuration page is used for setup and maintenance Email log support. For additional information and configuration requirements for Email support, see Logging on page 73.

Enabling or disabling Email support:

Select **Enabled** or **Disabled** from the Email Notifications drop-down menu and press **Apply**.

Setting the SMTP server address:

Enter the IP address or hostname in the SMTP Host field and press **Apply**.

Changing the SMTP server port:

Enter the port number in the SMTP Port field and press **Apply**.

Setting the 'From' email address:

Enter the 'from' email address in the 'From' Address field and press **Apply**.

Setting the 'To' email address:

Enter the 'to' email address in the Primary or Secondary 'Send To' Address field and press **Apply**.

Enabling or disabling event type notifications:

Select **Enabled** or **Disabled** from the Include...Messages drop-down menus and press **Apply**.

Tools

The Tools section contains access to rebooting the unit, uploading new firmware as well as resetting the unit to factory defaults. This section is available to administrative level users only.

Restart

Performing a warm boot:

Select the **Restart** from the Action drop-down menu and press **Apply**.

Note: System user/outlet/group configuration or outlet states are NOT changed or reset with this command.

Resetting to factory defaults:

See Chapter 5: for more information on resetting a Sentry to factory defaults from the HTML interface.

Uploading new firmware:

See Appendix B: for more information on uploading new firmware from the HTML interface.

Generating a new SSL X.509 certificate:

Select the **Restart and generate a new X.509 certificate** from the Action drop-down menu and press **Apply**.

Computing new SSH security keys:

Select the **Restart and compute new SSH keys** from the Action drop-down menu and press **Apply**.

Ping

The Ping feature may be used to test the Sentry's ability to contact another Ethernet enabled device's IP address. For LDAP support, it may also be used to test the configuration of the Domain Name server IP address by testing for proper name resolution.

Change Password

The Change Password feature allows users to change their own password.

NOTE: An administrator can always assign a new password.

Changing a password:

Enter the current password, enter a new password and verify the new password. Press **Apply**.

View Log

The View Log feature enables viewing of the internal system log. This feature logs all authentication attempts, power actions, configuration changes and other system events. The system memory stores more than 4000 entries in a continuously aging log. For permanent off-system log storage, the Syslog protocol is supported. For additional information and configuration requirements for the system log and Syslog support, see Logging on page 73.

NOTE: The system log is viewable only by users with administrative privileges.

Reviewing the system log:

Click on the **Previous 100 entries** or **Next 100 entries** link to navigate through the log.

Command Line Interface

Logging In

Logging in through Telnet requires directing the Telnet client to the configured IP address of the unit.

Logging in through the Console (RS232) port requires the use of a terminal or terminal emulation software configured to support ANSI or VT100 and a supported data rate (300, 1200, 2400, 4800, 9600, 19200, 38400, 57600, or 115200 BPS) - 8 data bits-no parity-one stop bit and Device Ready output signal (DTR or DSR).

To log in by RS-232 or Telnet:

1. Press **Enter**. The following appears, where **x.xx** is the firmware version:

```
Sentry Version x.xx  
Username:
```

NOTE: Logging in by Telnet will automatically open a session. It is not necessary to press Enter.

2. At the Username: and Password: prompts, enter a valid username and password. And press **Enter**.

You are given three attempts to enter a valid username and password combination. If all three fail, the session ends.

NOTE: The default Sentry username/password is admn/admn.

When you enter a valid username and password, the command prompt (Sentry:) appears. If a location identifier was defined, it will be displayed before the Sentry: prompt. See Creating a location description: on page 39 for more information.

Commands may be entered in any combination of uppercase and lowercase. All command characters must be entered correctly; there are no command abbreviations. A user must have administrative privileges to use the administration commands. The following tables list and briefly describe each command.

Operations Command Summary

Command	Description
On	Turns one or more outlets on
Off	Turns one or more outlets off
Reboot	Reboots one or more outlets
Status	Displays the on/off status of one or more outlets
IStat	Displays the status of the infeeds
Envmon	Displays the status of the integrated Environmental Monitor
Connect	Connects to a serial/Pass-Thru port
Login	Ends the current session and brings up the Username: prompt
Logout	Ends a session
Password	Changes the password for the current user
Quit	Ends a session
List Outlets	Lists all accessible outlets for the current user
List Ports	Lists all accessible serial/Pass-Thru ports for the current user
List Group	Lists all assigned outlets for a group name
List Groups	Lists all accessible groups for the current user

Administrative Command Summary

Add Groupouser	Grants a user access to one or more groups
Add Outlettogroup	Adds an outlet to a group name
Add Outlettouser	Grants a user access to one or all outlets
Add Porttouser	Grants a user access to one or all serial/Pass-Thru ports
Create Group	Adds a group name
Create User	Adds a user account
Delete Groupfromuser	Removes access to one or more groups for a user
Delete Outletfromgroup	Deletes an outlet from a group name
Delete Outletfromuser	Removes access to one or all outlets for a user
Delete Portfromuser	Removes access to one or all serial/Pass-Thru ports
List User	Displays all accessible outlets/groups/ports for a user
List Users	Displays privilege levels for all users
Remove Group	Deletes a group name
Remove User	Deletes a user account
Restart	Performs a warm boot
Set Banner	Set the pre-login banner text
Set DHCP	Enables or disables DHCP support
Set DNS	Sets the IP address of the Domain Name server
Set Envmon Name	Specifies a descriptive field fro the integrated Environmental Monitor
Set Envmon THS Name	Specifies a descriptive field for a temperature-humidity sensor
Set FTP Autoupdate	Enables or disables automatic FTP update support
Set FTP Autoupdate Day	Sets the automatic FTP update day
Set FTP Autoupdate Hour	Sets the automatic FTP update hour
Set FTP Directory	Specifies the directory for the file to be uploaded
Set FTP Filename	Specifies the file to be uploaded via FTP
Set FTP Filepath	Specifies the directory for the file to be uploaded
Set FTP Host	Sets the FTP Host IP address or hostname
Set FTP Password	Sets the password for the FTP Host
Set FTP Username	Sets the username for the FTP Host
Set FTP Server	Enables or disables the FTP server
Set Gateway	Sets the Gateway of the Sentry
Set HTTP	Enables or disables HTTP access
Set HTTP Port	Specifies the target port for HTTP access
Set HTTP Security	Specifies the HTTP server authentication method
Set Infeed Name	Specifies a descriptive field for the infeed
Set IPAddress	Sets the IP address of the Sentry
Set Location	Specifies a descriptive field for the HTML control screen and login banner
Set Option Button	Enables or disables the external configuration reset button
Set Option More	Enables or disables the 'more' prompt
Set Option StrongPasswords	Enables or disables strong password requirements
Set Option Tempscale	Sets the Environmental Monitor temperature scale
Set Outlet Name	Specifies a descriptive field for a device attached to an outlet
Set Outlet PostOnDelay	Sets the Post-On delay for an outlet
Set Outlet RebootDelay	Sets the reboot delay for all outlets
Set Outlet SeqInterval	Sets the sequencing interval for all outlets
Set Outlet Wakeup	Sets the wakeup state for an outlet

Administrative Command Summary (continued)

Set Port Name	Specifies a descriptive field for a serial/Pass-Thru port
Set Port Dsrchk	Sets the DSR active signal checking for a serial/Pass-Thru port
Set Port Speed	Set the connection speed for all serial/Pass-Thru ports
Set Port Timeout	Sets the inactivity timer for Pass-Thru sessions
Set SNTP	Sets the IP address or hostname of the SNTP servers
Set SNTP GMTOffset	Sets the local GMT offset applied to the SNTP date/time
Set Subnet	Sets the Subnet Mask of the Sentry
Set Telnet	Enables or disables Telnet access
Set Telnet Port	Sets the Telnet server port number
Set Tower Name	Specifies a descriptive field for the Sentry
Set User Access	Sets the access level for a user
Set User Envmon	Grants or removes privileges to view input/environmental monitoring status
Set User Password	Changes the password for a user
Show FTP	Displays FTP configuration information
Show Infeeds	Displays infeed configuration information
Show Network	Displays network configuration information
Show Options	Displays system option information
Show Outlets	Displays configuration information for all outlets
Show Ports	Displays serial/Pass-Thru port configuration information
Show SNTP	Displays SNTP configuration information
Show System	Displays system configuration information
Show Towers	Displays tower configuration information
Version	Displays the Sentry firmware version

To display the names of commands that you may execute:

At the command prompt, press **Enter**. A list of valid commands for the current user appears.

Operations Commands

Operations commands manage outlet states, provide information about the Sentry environment and control session operations.

Turning outlets on:

The On command turns on one or more outlets. When the command completes, a display indicating all outlets affected and their current states will be displayed.

To turn outlets on:

At the Sentry: prompt, type **on**, followed by an outlet name, and press **Enter**, or

Type **on**, followed by a group name, and press **Enter**, or

Type **on all** and press **Enter**.

Examples

The following command turns the second outlet on, using the outlet's absolute name:

```
Sentry: on .a2<Enter>
```

The following command turns on all the outlets in the group named ServerGroup_1:

```
Sentry: on ServerGroup_1<Enter>
```

Turning outlets off:

The Off command turns off one or more outlets. When the command completes, a display indicating all outlets affected and their current states will be displayed.

To turn outlets off:

At the Sentry: prompt, type **off**, followed by an outlet name, and press **Enter**, or

Type **off**, followed by a group name, and press **Enter**, or

Type **off all** and press **Enter**

Examples

The following command turns off the outlet named FileServer_1:

```
Sentry: off FileServer_1<Enter>
```

The following command turns off all outlets:

```
Sentry: off all<Enter>
```

Rebooting outlets:

The Reboot command reboots one or more outlets. This operation turns the outlet(s) off, delays for a user configurable period and then turns the outlet(s) on. When the command completes, a display indicating all outlets affected and their current states will be displayed.

NOTE: It is necessary to reissue the Status command to verify that the outlets have rebooted. See [Displaying outlet status for more information](#).

To reboot one or more outlets:

At the Sentry: prompt, type **reboot**, followed by an outlet name, and press **Enter**, or

Type **reboot**, followed by a group name, and press **Enter**, or

Type **reboot all** and press **Enter**.

Example

The following command reboots all the outlets in the group named ServerGroup_1:

```
Sentry: reboot ServerGroup_1<Enter>
```

Displaying outlet status:

The Status command displays the on/off status of one or more outlets. The command displays the status of only those outlets for which the current username has power control access.

This display includes the outlet absolute and descriptive names, the Outlet State reported to the Sentry by the outlet and the current Control State being applied by the Sentry. If you do not specify any parameter with this command, the status of all accessible outlets is displayed.

NOTE: If the user has access to more than 16 total outlets, the Status command will display the first 16 outlets with a prompt to view the remaining outlets.

For more information on outlet and control state values, see *Outlet Control* on page 12.

To display on/off status of one or more outlets:

At the Sentry: prompt, type **status**, followed by an outlet name, and press **Enter**, or

Type **status**, followed by a group name, and press **Enter**, or

Type **status** and press **Enter**.

Examples

The following command displays the on/off status of the outlet named FileServer_1:

```
Sentry: status WebServer_1<Enter>
Outlet  Outlet          Outlet  Control
ID      Name              State   State
.A2     WebServer_1       On      On
```

The following command displays the on/off status of all accessible outlets:

```
Sentry: status<Enter>
Outlet  Outlet          Outlet  Control
ID      Name              State   State
.A1     DataServer_1     On      On
.A2     WebServer_1      On      On
```

The following command displays the on/off status for outlets in the group ServerGroup_1:

```
Sentry: status ServerGroup_1<Enter>
Group: ServerGroup_1
Outlet  Outlet          Outlet  Control
ID      Name              State   State
.A1     DataServer_1     On      On
.A2     WebServer_1      On      On
```

Displaying accessible outlets:

The List Outlets command displays accessible outlets for the current user. The display includes the absolute and descriptive name of all outlets assigned to the current user.

To display accessible outlets:

At the Sentry: prompt, type **list outlets** and press **Enter**.

Example

The follow command displays all accessible outlets for the current user:

```
Sentry: list outlets<Enter>
Outlet  Outlet
ID      Name
.A1     DataServer_1
.A2     WebServer_1
```

Displaying accessible groups:

The List Groups command displays accessible groups for the current user.

To display accessible groups:

At the Sentry: prompt, type **list groups** and press **Enter**.

Example

The follow command displays all accessible groups for the current user:

```
Sentry: list groups<Enter>
Groups:
  ServerGroup_1
  RouterGroup_1
```

Displaying outlets assigned to a group:

The List Group command displays outlets assigned to the specified group name.

To display outlets assigned to a group:

At the Sentry: prompt, type **list group**, followed by the group name and press **Enter**.

Example

The follow command displays the outlets assigned to the group ServerGroup_1:

```
Sentry: list group ServerGroup_1<Enter>
Group: ServerGroup_1
  Outlet  Outlet
  ID      Name
  .A1     DataServer_1
  .A2     WebServer_1
```

Displaying accessible serial ports:

The List Ports command displays accessible serial ports for the current user.

To display accessible serial ports:

At the Sentry: prompt, type **list ports** and press **Enter**.

Example

The follow command displays all accessible serial ports for the current user:

```
Sentry: list ports<Enter>
Port      Port
ID        Name
Console  Console
```

Displaying infeed status:

The Istat command displays the status of one or more infeeds.

This display includes the infeed absolute and descriptive names and the Input Status.

To display status of one or more infeeds:

Type **istat** and press **Enter**.

Example

The following command displays the infeed status:

```
Sentry: istat
Input      Input      Input
Feed ID    Feed Name    Status
.AA       HQ_1_Infeed_A    On
```

Connecting to a serial device:

The Connect command allows Pass-Thru serial connection to devices attached to the standard serial port (Console).

To connect to a serial device:

At the Sentry: prompt, type **connect console** and press **Enter**.

To disconnect from a serial device:

Type **!*break** and press **Enter**.

Displaying the status of the Environmental Monitor:

The Envmon command displays the status of the integrated Environmental Monitor.

By default, only administrative user accounts are allowed access to the Envmon command. An administrator may use the Set User Envmon command to enable and disable access for other user accounts.

To display the status of the Environmental Monitor:

At the Sentry: prompt, type **envmon** and press **Enter**.

Example

The following command displays the status of the Environmental Monitor.

```
Sentry: envmon<Enter>
Environmental Monitor .A
  Name: Florida_HQ_1           Status: Normal
  Temperature/Humidity Sensors
    ID   Name                    Temperature  Humidity
    .A1  Temp_Humid_Sensor_A1     Not Found   Not Found
    .A2  T/H2_Florida_HQ_1        23.5 Deg. C  22 % RH
```

Changing a password:

The Password command changes the current user's password. For security, when you type a password, the characters are not displayed on the screen. See *For commands requiring* an outlet name, you may specify it in one of two ways: a predefined absolute name or a descriptive name assigned by an administrator.

Absolute names are specified by a period (.) followed by a tower letter and outlet number. The tower letter for the Intelligent IPM is A.

Outlets may also be included in one or more named groups of outlets, enabling you to issue a command that affects all outlets in a named group.

Usernames and Passwords for more information.

To change a password:

At the Sentry: prompt, type **password** and press **Enter**.

At the Enter Current Password: prompt, type the current password and press **Enter**.

At the Enter New Password: prompt, type the new password and press **Enter**. Passwords may contain 1-16 characters.

At the Verify Password: prompt, retype the new password and press **Enter**.

Starting a new session:

The Login command activates the Username: prompt. The current session ends, allowing a user to log in and start a new session under a different username.

To start a new session:

At the Sentry: prompt, type **login** and press **Enter**. The Username: prompt appears.

Ending a session:

The Quit or Logout commands ends a session. A session ends automatically when no activity is detected for five minutes, or upon loss of connection.

To end a session:

At the Sentry: prompt, type **quit** and press **Enter**, or

Type **logout** and press **Enter**.

Administration Commands

Administration commands may only be issued by a user with administrative privileges, such as the predefined Admn user or another user who has been granted administrative privileges with the Set User Admnpriv command.

User Administration

Creating a user account:

The Create User command creates a user account with the specified username and password. See *Usernames and Passwords* in this chapter for more information.

To create a user account:

At the Sentry: prompt, type **create user**, optionally followed by a 1-16 character username (Spaces are not allowed, and usernames are not case sensitive). Press **Enter**.

At the Password: prompt, type a password of 1-16 alphanumeric and other typeable characters - (ASCII 32 to 126 decimal) are allowed; passwords are case sensitive. Press **Enter**.

At the Verify Password: prompt, retype the password. Press **Enter**.

Example

The following command creates the user account JaneDoe:

```
Sentry: create user JaneDoe<Enter>
Password: <Enter>
Verify New Password: <Enter>
```

For security, password characters are not displayed.

Removing a user account:

The Remove User command removes a user account.

NOTE: You may remove the predefined user account Admn only if another user account has been granted administrative privileges using the Set User Admnpriv command.

To remove a user account:

At the Sentry: prompt, type **remove user**, optionally followed by a username. Press **Enter**.

Changing a password:

The Set User Password command changes a user's password. For security, when you type a password, the characters are not displayed on the screen. See *Usernames and Passwords* for more information.

To change a password:

At the Sentry: prompt, type **set user password**, followed by a username and press **Enter**.

At the Password: prompt, type the new password and press **Enter**. Passwords may contain 1-16 characters.

At the Verify Password: prompt, retype the new password and press **Enter**.

Example

The following command changes the password for the user JohnDoe:

```
Sentry: set user password johndoe<Enter>
Password: <Enter>
Verify Password: <Enter>
```

For security, password characters are not displayed.

Setting user access level privileges:

The Set User Access command sets the access level privileges for a user. The Sentry has the following defined access privilege levels; Admin, Power User, User, Reboot-Only, On-Only and View-Only. For more information on user access levels, see *Changing a user's access privilege level:* on page 17.

The administrator may also grant administrative privileges to other user accounts allowing the Sentry to have more than one administrative-level user.

NOTE: You cannot remove administrative privileges from the Admn user unless another user has already been given administrative access level privileges created.

To set the access level privilege for a user:

At the Sentry: prompt, type **set user access**, followed by **admin**, **poweruser**, **user**, **rebootonly**, **ononly** or **viewonly**, optionally followed by a username and press **Enter**.

Examples

The following command sets the user access level for JohnDoe to Admin:

```
Sentry: set user access admin johndoe<Enter>
```

The following command sets the user access level for JaneDoe to User:

```
Sentry: set user access user janedoe<Enter>
```

Granting and removing Environmental Monitoring viewing privileges:

The Set User Envmon command grants or removes Environmental Monitoring viewing privileges to/from a user.

To grant or remove Environmental Monitoring viewing privileges for a user:

At the Sentry: prompt, type **set user envmon** followed by **on** or **off**, optionally followed by a username and press **Enter**.

Example

The following command grants input load privileges to the user JohnDoe:

```
Sentry: set user envmon on johndoe<Enter>
```

Displaying the access privilege levels:

The List Users command displays all defined users with their access privilege level.

To display user access privilege levels:

At the Sentry: prompt, type **list users** and press **Enter**.

Example

The following command displays all users with their access privilege level:

```
Sentry: list users<Enter>
```

User Name	Privilege Level	Environmental Monitoring
JOHNDOE	Admin	Allowed
JILLDOE	Power-User	Allowed
JANEDOE	User	Allowed
JAKEDOE	Reboot-Only	Not Allowed
JOSEYDOE	On-Only	Not Allowed
JOEDOE	View-Only	Not Allowed

Adding outlet access to a user:

The Add OutletToUser command grants a user access to one or all outlets. To grant access for more than one outlet, but not all outlets, you must use multiple Add OutletToUser commands.

To grant outlet access to a user:

At the Sentry: prompt, type **add outlettouser**, optionally followed by an outlet name and a username. Press **Enter**, or

Type **add outlettouser all**, followed by a username and press **Enter**.

Examples

The following commands grant the user JaneDoe access to outlets A1 and Webserver_1:

```
Sentry:add outlettouser .a1 janedoe<Enter>
Sentry:add outlettouser WebServer_1 janedoe<Enter>
```

Deleting outlet access for a user:

The Delete OutletFromUser command removes a user's access to one or all outlets. You cannot remove access to any outlet for an administrative level user.

To delete outlet access for a user:

At the Sentry: prompt, type **delete outletfromuser**, optionally followed by an outlet name and a username. Press **Enter**, or

Type **delete outletfromuser all**, followed by a username and press **Enter**.

Adding group access to a user:

The Add GroupToUser command grants a user access to a group. To grant access for more than one group, you must use multiple Add GroupToUser commands.

To grant group access to a user:

At the Sentry: prompt, type **add grouptouser**, optionally followed by a group name and a username. Press **Enter**.

Examples

The following commands grants to user JaneDoe access to the groups ServerGroup_1 and ServerGroup_2:

```
Sentry:add GroupToUser ServerGroup_1 janedoe<Enter>
Sentry:add GroupToUser ServerGroup_2 janedoe<Enter>
```

Deleting group access for a user:

The Delete GroupFromUser command removes a user's access to a group. You cannot remove access to any group for an administrative level user.

To delete group access for a user:

At the Sentry: prompt, type **delete GroupFromUser**, optionally followed by a group name and a username. Press **Enter**.

Adding serial port access to a user:

The Add PortToUser command grants a user access to the serial port.

To grant serial port access to a user:

At the Sentry: prompt, type **add porttouser console** and a username. Press **Enter**.

Deleting serial port access for a user:

The Delete PortFromUser command removes a user's access to the serial port. You cannot remove access to the serial port for an administrative level user.

To delete serial port access for a user:

At the Sentry: prompt, type **delete portfromuser console** and a username. Press **Enter**.

Displaying user outlet, group and serial port access:

The List User command displays all accessible outlets, groups and serial ports for a user.

To display user outlet, group and serial port access:

At the Sentry: prompt, type **list user**, optionally followed by a username. Press **Enter**.

Example

The following command displays information about the user JaneDoe:

```
Sentry: list user janedoe<Enter>
Username: JANEDOE
  Outlet  Outlet
  ID      Name
  .A1     DataServer_1
  .A2     WebServer_1
Groups:
  ServerGroup_1
  ServerGroup_2
More (Y/es N/o): Y
Ports:
  Port      Port
  ID        Name
  Console   Console
```

JaneDoe may access the following outlets, groups and serial ports: outlet A1 which has a descriptive name of DataServer_1, outlet A2 which has a descriptive name of WebServer_1, group ServerGroup_1, group ServerGroup_2, and Console serial port.

Outlet Administration

Setting the sequencing interval:

The Set Outlet SeqInterval commands sets the power on sequencing interval for all outlets.

To set the sequencing interval:

At the Sentry: prompt, type **set outlet seqinterval all**, followed by a value from 0 to 15 (in seconds) and press Enter.

Setting the reboot delay:

The Set Outlet RebootDelay commands sets the reboot delay for all outlets.

To set the sequencing interval:

At the Sentry: prompt, type **set outlet rebootdelay all**, followed by a value from 5 to 60 (in seconds) and press Enter.

Creating a descriptive outlet name:

The Set Outlet Name command assigns a descriptive name to an outlet. You may use this name in commands that require an outlet name as an alternative to using the outlet's absolute name.

To create an outlet name:

At the Sentry: prompt, type **set outlet name** followed by the absolute outlet name, then a descriptive name of up to 24 alphanumeric and other typeable characters - (ASCII 33 to 126 decimal) are allowed; spaces are not allowed; outlet names are not case sensitive. Press **Enter**.

Example

The following command adds the descriptive name DataServer_1 to outlet .a1:

```
Sentry: set outlet name .a1 DataServer_1<Enter>
```

Setting the outlet wakeup state:

The Set Outlet Wakeup command set the default wakeup state for that outlet. In the event of a system-wide power loss, this state will be applied to the outlet when power is restored.

The wakeup state may be set to On, Off or Last. Upon restoration of system power; If set to On, the Sentry will apply power to that outlet. If set to Off, the Sentry will not apply power to that outlet. If set to Last, the Sentry will apply the last known power state.

To set the wakeup state:

At the Sentry: prompt, type **set outlet wakeup**, followed by **on**, **off** or **last** and the outlet name. Press **Enter**.

Example

The following command sets the wakeup state for outlet .a1 to off:

```
Sentry: set outlet wakeup off .a1<Enter>
```

Setting the outlet Post-On delay:

The Set Outlet PostOnDelay command is used set the Post-On delay for an outlet. This feature allows the administrator to manage boot dependencies during power-on sequencing or group commands by delaying the sequencing of subsequent outlets after an outlet has been powered on.

NOTE: This delay is applied in addition to the general sequencing interval.

To set the outlet Post-On delay

At the Sentry: prompt, type **set outlet postondelay**, followed by a value from 0 to 900 (in seconds) and press **Enter**.

Example

The following command set the Post-On delay for outlet .a2 to 90 seconds:

```
Sentry: set outlet postondelay .a2 90<Enter>
```

Displaying outlet information:

The Show Outlets command displays information about all outlets. This information includes:

- Sequencing and reboot timer values
- Descriptive outlet name, if applicable
- Outlet wakeup state and Post-On settings

To display outlet information:

At the Sentry: prompt, type **show outlets** and press **Enter**.

Example

The following command displays all outlet information:

```
Sentry: show outlets<Enter>
Outlet  Outlet      Wakeup  Post-On
ID      Name           State   Delay (seconds)
.A1     TowerA_Outlet1 Off      0
.A2     TowerA_Outlet2 On       90
More (Y/es N/o):
Outlet Options:
Sequence Interval:  2 seconds
Reboot Delay:      15 seconds
```

Group Administration

Creating a group name:

The Create Group command creates a new group name.

To create a group name:

At the Sentry: prompt, type **create group** optionally followed by a descriptive name of up to 24 alphanumeric and other typeable characters - (ASCII 33 to 126 decimal) are allowed; spaces are not allowed; group names are not case sensitive. Press **Enter**.

Example

The following command creates group name ServerGroup_1:

```
Sentry: create group ServerGroup_1<Enter>
```

Removing a group name:

The Remove Group command removes a group name.

To remove a group name:

At the Sentry: prompt, type **remove group**, optionally followed by a username. Press **Enter**.

Example

The following command removes group name ServerGroup_1:

```
Sentry: remove group ServerGroup_1<Enter>
```

Adding an outlet to a group:

The Add OutletToGroup command adds an outlet to a group. To add more than one outlet, but not all outlets, you must use multiple Add OutletToGroup commands.

To add an outlet to a group:

At the Sentry: prompt, type **add outlettogroup**, optionally followed by an outlet name and group name. Press **Enter**, or

Type **add OutletToGroup**, followed by **all** and the group name. Press **Enter**.

Examples

The following commands uses absolute outlet names to add outlets A1 and A2 to group name ServerGroup_1:

```
Sentry:add OutletToGroup .a1 ServerGroup_1<Enter>
Sentry:add OutletToGroup .a2 ServerGroup_1<Enter>
```

The following commands uses the outlets' descriptive names to add outlets DataServer_1 and WebServer_1 to group name ServerGroup_1:

```
Sentry:add OutletToGroup DataServer_1 ServerGroup_1<Enter>
Sentry:add OutletToGroup WebServer_1 ServerGroup_1<Enter>
```

The following command add all outlets to group name ServerGroup_1:

```
Sentry: add OutletToGroup<Enter>
Outletname: all<Enter>
Groupname: ServerGroup_1<Enter>
```

Deleting an outlet from a group:

The Delete OutletFromGroup command deletes an outlet from a group. To delete more than one outlet, but not all outlets, you must use multiple Delete OutletToGroup commands.

To delete an outlet from a group:

At the Sentry: prompt, type **delete outletfromgroup**, optionally followed by an outlet name and a group name. Press **Enter**, or

Type **delete outletfromgroup**, followed by **all** then the group name. Press **Enter**.

Environmental Monitor Administration

Creating a descriptive Environmental Monitor name:

The Set Envmon Name command assigns a descriptive name to the integrated Environmental Monitor. This descriptive name is displayed when the Evnmon command is issued.

To create an Environmental Monitor name:

At the Sentry: prompt, type **set envmon name** followed by the absolute Environmental Monitor name, then a descriptive name of up to 24 alphanumeric and other typeable characters - (ASCII 33 to 126 decimal) are allowed; spaces are not allowed. Press **Enter**.

Example

The following command adds the descriptive name Florida_HQ_1 to the Environmental Monitor:

```
Sentry: set envmon name .a Florida_HQ_1<Enter>
```

Creating a descriptive temperature/humidity sensor name:

The Set Envmon THS Name command assigns a descriptive name to a temperature/humidity sensor. This descriptive name is displayed when the Evnmon command is issued.

To create an temperature/humidity sensor name:

At the Sentry: prompt, type **set envmon ths name** followed by the absolute name of the temperature/humidity sensor, then a descriptive name of up to 24 alphanumeric and other typeable characters - (ASCII 33 to 126 decimal) are allowed; spaces are not allowed. Press **Enter**.

Example

The following command adds the descriptive name T/H2_Florida_HQ_1 to the second temperature/humidity sensor:

```
Sentry: set envmon ths name .a2 T/H2_Florida_HQ_1<Enter>
```

Serial Port Administration

Creating a descriptive serial port name:

The Set Port Name command assigns a descriptive name to a serial port. You may use this name in commands that require a port name as an alternative to using the port's absolute name.

To create an port name:

At the Sentry: prompt, type **set port name** followed by the absolute outlet name, then a descriptive name of up to 24 alphanumeric and other typeable characters - (ASCII 33 to 126 decimal) are allowed; spaces are not allowed; port names are not case sensitive. Press **Enter**.

Example

The following command adds the descriptive name Rack1 to Console port:

```
Sentry: set port name console Rack1<Enter>
```

Setting the serial ports data-rate:

The Set Port Speed command sets the default data-rate for the serial port. Valid data-rates are 1200, 2400, 4800, 9600, 19200, 38400, 57600 and 115200.

To set the serial port data-rate:

At the Sentry: prompt, type **set port speed**, follow by the data-rate and press **Enter**.

Example

The following command sets the serial ports data-rate to 38400 BPS:

```
Sentry: set port speed 38400<Enter>
```

Enabling or disabling active signal checking for serial connections:

The Set Port Dsrchk command enables or disables active signal checking for serial connections to devices attached to any of the available serial ports.

To enable or disable active signal checking for serial connections:

At the Sentry: prompt, type **set port dsrchk console, on** or **off**, and press **Enter**.

Setting the serial port timeout value:

The Set Port Timeout command is used to set the serial port inactivity timeout period. The timeout period defines the maximum period of inactivity before automatically closing the Pass-Thru session. The valid range for the period parameter is 0 to 5 (in minutes). The default period is 5.

NOTE: Setting the timeout to '0' disables the timer.

To set the serial port timeout value:

At the Sentry: prompt, type **set port timeout**, followed by a value from 0 to 5 (in minutes) and press **Enter**.

Displaying serial port information:

The Show Ports command displays information about all serial ports. This information includes:

- Serial port data rate
- Descriptive port name, if applicable
- DSR signal checking settings

To display serial port information:

At the Sentry: prompt, type **show ports** and press **Enter**.

Example

The following command displays all serial port information:

```
Sentry: show ports<Enter>
Serial Port Configuration
  ALL Ports:
    Baud Rate: 38400      Connection Timeout: 5 minutes
    Port ID: Console     Port Name: CONSOLE
    DSR Check: ON
```

System Administration

Creating a pre-login banner:

The Set Banner command specifies text that appears prior to the login authentication. This feature allows administrators to configure a message up to 2070 characters for display of legal, disclaimer or other text as required by application. If left blank, the user will be taken directly to the login prompt.

NOTE: For SSH sessions, the 'keyboard-interactive' authentication method must be used for the banner to display.

To create a pre-login banner:

At the Sentry: prompt, type **set banner** and press **Enter**. Type the desired pre-login banner text and when finished type **Ctrl-z**.

Creating a location description:

The Set Location command specifies text that appears in the HTML control screen's Location field. The text is also appended to a Welcome to banner that appears when a user successfully logs in serially or through a Telnet session.

If you do not issue this command, or if you issue this command without specifying any text, the control screen's Location field will be blank and no Welcome to banner will be displayed.

To create a location description:

At the Sentry: prompt, type **set location** followed by a descriptive name of up to 24 alphanumeric and other typeable characters - (ASCII 33 to 126 decimal) are allowed; spaces are allowed. Press **Enter**.

Omitting any characters after typing 'set location' deletes any previously specified text.

Examples

The following command specifies Florida HQ as the descriptive location for the control screen and the login banner:

```
Sentry: set location Florida HQ<Enter>
```

The following command deletes any previously specified location description:

```
Sentry: set location<Enter>
```

In this case, the control screen's Location field will be blank, and no welcome banner will be displayed after a successful login.

Displaying system configuration information:

The Show System command displays all system configuration information.

- Firmware version
- NIC module serial number and MAC address
- Hardware revision code and Flash size
- Uptime since last system restart
- System location description

See Chapter 4: Advanced Operations on page 49 for more information on SNMP.

To display system configuration information:

At the Sentry: prompt, type **show system** and press **Enter**.

Example

```
System Information
  F/W Version:   Sentry Version 5.2b
  NIC S/N:       1600001
  MAC Address:   00-0a-9c-10-00-01
  H/W Rev Code:  0
  Flash Size:    1 MB
  Uptime:        0 days 6 hours 14 minutes 1 second
  Location:      Florida HQ
```

Enabling or disabling strong passwords:

The Set Option Strong Password command is used to enable or disable the requirements for strong passwords. When enabled, all new passwords must be a minimum of 8 characters in length with at least one uppercase letter, one lowercase letter, one number and one special character.

To enable or disable strong passwords:

At the Sentry: prompt, type **set option strong password**, followed by **enabled** or **disabled** and press **Enter**.

Enabling or disabling the external configuration reset button:

The Set Option Button command enables or disables the external configuration reset button. This feature can enhance system security by protecting the Sentry configurations from being reset locally.

NOTE: If this feature has been enabled and the administrative account username/password has been lost, then the Sentry must be returned to the factory for non-warranty reset of the configuration.

To enable or disable the configuration reset button:

At the Sentry: prompt, type **set option button**, followed by **enabled** or **disabled** and press **Enter**.

Enabling or disabling the 'more' prompt:

The Set Option More command enables or disables the 'more' prompt for display of data larger than the terminal window.

To enable or disable 'more':

At the Sentry: prompt, type **set option more**, followed by **enabled** or **disabled** and press **Enter**.

Setting the temperature scale:

The Set Option TempScale command sets the temperature scale that the Sentry will report in.

To set the temperature scale:

At the Sentry: prompt, type **set option tempscale**, followed by **celsius** or **fahrenheit** and press **Enter**.

Displaying system options:

The Show Options command displays all system option information.

To display system option information:

At the Sentry: prompt, type **show options** and press **Enter**.

Example

```
Sentry: show options
System Options
  Display Orientation:      NORMAL
  Strong Passwords:       DISABLED
  Configuration Reset Button:  ENABLED
  More Prompt:            ENABLED
  Temperature Scale:      CELSIUS
```

Creating a descriptive tower name:

The Set Tower Name command assigns a descriptive name to a tower. This descriptive name is displayed when the Show Traps command is issued. See *Displaying trap configuration information* on page 41 for more information on the Show Traps command.

To create a tower name:

At the Sentry: prompt, type **set tower name**, followed by the absolute tower name, then the descriptive name of up to 24 alphanumeric and other keyboard characters (ASCII 33 to 126 decimal - spaces are not allowed). Press **Enter**.

Example

The following command adds the descriptive name Florida_HQ_1 to tower .a:

```
Sentry: set tower name .a Florida_HQ_1<Enter>
```

Displaying tower information:

The Show Towers command displays information about the Sentry. This information includes the absolute and descriptive Sentry names.

To display tower information:

At the Sentry: prompt, type **show towers** and press **Enter**.

Example

```
Sentry: show towers<Enter>
Tower   Tower
ID      Name
.A      Florida_HQ_1
```

Creating a descriptive infeed name:

The Set Infeed Name command assigns a descriptive name to an infeed. This descriptive name is displayed when the Show Traps command is issued. See *Displaying trap configuration information* on page 41 for more information on the Show Traps command.

To create a infeed name:

At the Sentry: prompt, type **set infeed name**, followed by the absolute infeed name, then the descriptive name of up to 24 alphanumeric and other keyboard characters (ASCII 33 to 126 decimal - spaces are not allowed). Press **Enter**.

Example

The following command adds the descriptive name HQ_1_Infeed_A to the infeed on the Sentry:

```
Sentry: set infeed name .aa HQ_1_Infeed_A<Enter>
```

Displaying infeed information:

The Show Infeeds command displays information about all infeeds. This information includes the absolute and descriptive infeed names.

To display tower information:

At the Sentry: prompt, type **show infeeds** and press **Enter**.

Example

```
Sentry: show infeeds<Enter>
Input   Input
Feed ID Feed Name
.AA     HQ_1_Infeed_A
```

Displaying the Sentry firmware version:

The Version command displays the Sentry firmware version.

To display the firmware version:

At the Sentry: prompt, type **version** and press **Enter**.

Performing a warm boot:

The Restart command performs a warm boot of the Sentry.

NOTE: System user/outlet/group/port configuration or outlet states are NOT changed or reset with this command.

To perform a warm boot:

At the Sentry: prompt, type **restart** and press **Enter**.

TCP/IP Administration

NOTE: A restart of the Sentry is required after setting or changing ANY TCP/IP configurations. See [Performing a warm boot](#) on page 41 for more information.

Enabling or disabling DHCP support:

The Set DHCP command enables or disables DHCP support.

To enable or disable DHCP support:

At the Sentry: prompt, type **set dhcp**, followed by **enabled** or **disabled** and press **Enter**.

Setting the IP address:

The Set Ipaddress command sets the TCP/IP address of the network interface controller.

To set the IP address:

At the Sentry: prompt, type **set ipaddress**, followed by the IP address and press **Enter**.

Example

The following command sets the IP address to 12.34.56.78:

```
Sentry: set ipaddress 12.34.56.78<Enter>
```

Setting the subnet mask:

The Set Subnet command sets the subnet mask for the network the PT40 will be attached to.

To set the subnet mask:

At the Sentry: prompt, type **set subnet**, followed by the subnet mask and press **Enter**.

Example

The following command sets the subnet mask to 255.0.0.0

```
Sentry: set subnet 255.0.0.0<Enter>
```

Setting the gateway:

The Set Gateway command sets the IP address of the default gateway the Sentry uses to access external networks.

To set the gateway IP address:

At the Sentry: prompt, type **set gateway**, followed by the gateway IP address and press **Enter**.

Example

The following command set the gateway IP address to 12.34.56.1:

```
Sentry: set gateway 12.34.56.1<Enter>
```

Setting the DNS IP address:

The Set DNS command sets the TCP/IP address of the Domain Name server (DNS).

To set the DNS IP address:

At the Sentry: prompt, type **set**, followed by **dns1** or **dns2** and the Domain Name server's IP address. Press **Enter**.

Example

The following command sets the primary Domain Name server IP address to 98.76.54.254:

```
Sentry: set dns1 98.76.54.254<Enter>
```

Displaying network configuration information:

The Show Network command displays TCP/IP, Telnet, SSH, Web, SSL and SNMP configuration information.

- IP address, subnet mask, gateway and DNS IP addresses
- Enabled-disabled status and port numbers for Telnet, SSH, HTTP,SSL and SNMP support
- HTTP authentication method and SSL access setting
- Network status

See Chapter 4: Advanced Operations on page 49 for more information on SNMP and Remote Authentication

To display network configuration information:

At the Sentry: prompt, type **show network** and press **Enter**.

Example

The following command displays the network configuration information:

```
Sentry: show network<Enter>
Network Configuration
  IP Address:      12.34.56.78           DNS1: 98.76.54.254
  Subnet Mask:    255.0.0.0           DNS2: 0.0.0.0
  Gateway:        12.34.56.1
  Telnet:         Enabled              Port: 23
  SSH:           Enabled              Port: 65535
  HTTP:          Enabled              Port: 80      Security: BASIC
  SSL:           Enabled              Access: Required
  SNMP:          Enabled
Network Status
  Link:           Up
  Speed:          100 Mbps
  Duplex:         Full
  Negotiation:   Auto
```

HTTP Administration

NOTE: A restart is required after setting or changing ANY Telnet/Web configurations. See *Performing a warm boot* on page 41 for more information.

Enabling and disabling HTTP support:

The Set HTTP command is used to enable or disable HTTP support.

To enable or disable HTTP support:

At the Sentry: prompt, type **set http**, followed by **enabled** or **disabled** and press **Enter**.

Changing the HTTP server port:

With HTTP support enabled, the HTTP server watches and responds to requests on the default HTTP port number 80. This port number may be changed using the Set HTTP Port command.

To change the HTTP port:

At the Sentry: prompt, type **set http port**, followed by the port number and press **Enter**.

Example

The following changes the HTTP port number to 2048:

```
Sentry: set HTTP port 2048<Enter>
```

Setting the HTTP authentication method:

The Set HTTP Security command is used to set the method of authentication. The Sentry HTTP server supports two authentication methods for security and validation of the username-password – Basic and MD5 digest.

For more information on authentication methods, see *Setting the HTTP authentication method:* on page 15.

To set the HTTP authentication method:

At the Sentry: prompt, type **set http security**, followed by **basic** or **md5** and press **Enter**.

Telnet Administration

NOTE: A restart of the Sentry is required after setting or changing ANY Telnet/Web configurations. See [Performing a warm boot](#) on page 41 for more information.

Enabling and disabling Telnet support:

The Set Telnet command is used to enable or disable Telnet support.

To enable or disable Telnet support:

At the Sentry: prompt, type **set telnet**, followed by **enabled** or **disabled** and press **Enter**.

Changing the Telnet port:

With Telnet support enabled, the Telnet server watches and responds to requests on the default Telnet port number 23. This port number may be changed using the Set Telnet Port command.

To change the Telnet socket:

At the Sentry: prompt, type **set telnet port**, followed by the port number and press **Enter**.

Example

The following changes the Telnet port number to 7001:

```
Sentry: set telnet port 7001<Enter>
```

FTP Administration

You may upload new versions of firmware into the Sentry using File Transfer Protocol (FTP). This allows access to new firmware releases for firmware improvements and new features additions. The following commands are used to configure the Sentry for an FTP firmware upload. See Appendix B: Uploading Firmware for more information on initiating a FTP firmware upload.

Setting the FTP host address:

The Set FTP Host command sets the FTP host IP address or hostname allowing for firmware file uploads.

To set the FTP Host address:

At the Sentry: prompt, type **set ftp host**, followed by the IP address or hostname and press **Enter**.

Examples

The following command sets the FTP host IP address to 12.34.56.99:

```
Sentry: set ftp host 12.34.56.99<Enter>
```

The following command sets the FTP hostname to ftp.servertech.com:

```
Sentry: set ftp host ftp.servertech.com<Enter>
```

Setting the FTP username:

The Set FTP Username command sets the username as required by the FTP Host.

To set the FTP username:

At the Sentry: prompt, type **set ftp username**, followed by the FTP username and press **Enter**.

Example

The following command sets the FTP username to Guest:

```
Sentry: set ftp username guest<Enter>
```

Setting the FTP Password:

The Set FTP Password command sets the password as required by the FTP Host.

To set the FTP password:

At the Sentry: prompt, type **set ftp password**, followed by the FTP password and press **Enter**.

Example

The following command sets the FTP password to OpenSesame:

```
Sentry: set ftp password OpenSesame<Enter>
```

Setting the filename to be uploaded:

The Set FTP Filename command sets the filename of the firmware file to be uploaded.

To set the FTP filename:

At the Sentry: prompt, type **set ftp filename**, followed by the firmware filename and press **Enter**.

Example

The following command sets the FTP filename to snb_s50a.bin:

```
Sentry: set ftp filename snb_s50a.bin<Enter>
```

Setting the directory for the file to be uploaded:

The Set FTP Directory or Set FTP Filepath commands set the directory for the firmware file to be uploaded.

To set the FTP directory:

At the Sentry: prompt, type **set ftp directory**, followed by the directory and press **Enter**.

Or, type **set ftp filepath**, followed by the directory and press **Enter**

Example

The following command sets the FTP directory to ftp://Sentry:

```
Sentry: set ftp directory ftp://sentry<Enter>
```

Enabling or disabling automatic updates:

The Set FTP Autoupdate command is used to enable or disable automatic firmware update support.

To enable or disable automatic updates:

At the Sentry: prompt, type **set ftp autoupdate**, followed by **enabled** or **disabled** and press **Enter**.

Setting the automatic update scheduled day:

The Set FTP Autoupdate Day command is used to set the day when automatic updates occur.

To set the automatic update day:

At the Sentry: prompt, type **set ftp autoupdate day**, followed by a day of the week or **everyday** and press **Enter**.

Example

The following command sets the automatic update day to Sunday:

```
Sentry: set ftp autoupdate day sunday<Enter>
```

Setting the automatic update scheduled hour:

The Set FTP Autoupdate Hour command is used to hour of the day when automatic updates occur.

To set the automatic update hour:

At the Sentry: prompt, type **set ftp autoupdate hour**, followed by an hour of the day and press **Enter**.

Examples

The following command sets the automatic update hour to 12 AM:

```
Sentry: set ftp autoupdate hour 12am<Enter>
```

The following command sets the automatic update hour to 3 PM:

```
Sentry: set ftp autoupdate hour 3pm<Enter>
```

Displaying FTP configuration information:

The Show FTP command displays all FTP configuration information.

- FTP Host IP address
- FTP Host username and password
- Firmware filepath and filename

To display FTP configuration information:

At the Sentry: prompt, type **show ftp** and press **Enter**.

Example

The following command displays the FTP configuration information:

```
Sentry: show ftp<Enter>
FTP Configuration
Host:      ftp.servertech.com
Username:  guest
Password:  OpenSesame
Directory: ftp://sentry
Filename:  snb_s52a.bin
FTP Automatic Updates Configuration
Automatic Updates: 12.34.56.99
Scheduled Day:     Sunday
Scheduled Hour:    3 PM
```

SNTP Administration

Sentry supports the use of a network time service to provide a synchronized time reference.

Setting the SNTP server address:

The Set SNTP command is used to set the primary and secondary SNTP server addresses.

To set the SNTP server address:

At the Sentry: prompt, type **set sntp**, followed by **primary** or **secondary**, and the SNTP server IP address or hostname. Press **Enter**.

Examples

The following command sets the primary SNTP server address to 204.152.184.72:

```
Sentry: set sntp primary 204.152.184.72<Enter>
```

The following command sets the secondary SNTP server address to cuckoo.nevada.edu:

```
Sentry: set sntp secondary cuckoo.nevada.edu<Enter>
```

Setting the local GMT offset:

The Set SNTP GMToffset command is used to set the offset from GMT for the date/time returned by SNTP. The offset can be configured in whole hours between -12 and 12 hours.

NOTE: The Sentry does not support automatic adjustment for daylight savings.

To set the local GMT offset:

At the Sentry: prompt, type **set sntp gmtoffset**, followed by the offset value, and press **Enter**.

Examples

The following command sets the local GMT offset to -12:

```
Sentry: set sntp gmtoffset -12<Enter>
```

Displaying SNTP configuration information:

The Show SNTP command displays all SNTP configuration information.

To display SNTP configuration information

At the Sentry: prompt, type **show sntp** and press **Enter**.

Example

The following command displays the SNTP configuration information:

```
Sentry: show sntp <Enter>
      Date/Time (Local GMT Offset -12): 2006-02-21  21:32:48
      Primary Host:      204.152.184.72
      Secondary Host:    cuckoo.nevada.edu
```

Chapter 4: Advanced Operations

SSL	50
Enabling and Setting up SSL Support	50
SSL Technical Specifications	50
SSH	51
Enabling and Setting up SSH Support	51
SSH Technical Specifications	51
SNMP	52
MIB, OID and Support	52
Enabling and Setting up SNMP Support	52
SNMP Traps	54
Configuring Traps	56
LDAP	59
Enabling and Setting up LDAP Support	60
Configuring LDAP Groups	64
LDAP Technical Specifications	67
TACACS+	68
Enabling and Setting up TACACS+ Support	68
Configuring TACACS+ Privilege Levels	70
TACACS+ Technical Specifications	72
LOGGING	73
Internal System Log	73
Syslog	73
Email	74
UPLOAD/DOWNLOAD	77
Sentry Integrated FTP Server	77
FTP Configuration Files	77
Upload/Download Process	78

SSL

Secure Socket Layers (SSL) version 3 enables secure HTML sessions between a Sentry Remote Power Manager and a remote user. SSL provides two chief features designed to make TCP/IP (Internet) transmitted data more secure:

- Authentication – The connecting client is assured of the identity of the server.
- Encryption – All data transmitted between the client and the server is encrypted rendering any intercepted data unintelligible to any third party.

SSL uses the public-and-private key encryption system by RSA, which also requires the use of digital certificates. An SSL Certificate is an electronic file uniquely identifying individuals or websites and enables encrypted communication; SSL Certificates serve as a kind of digital passport or credential. The Sentry product's SSL Certificate enables the client to verify the Sentry's authenticity and to communicate with the Sentry securely via an encrypted session, protecting confidential information from interception and hacking.

SSL Command Summary

Command	Description
Set SSL	Enables/disables SSL support
Set SSL Access	Sets SSL access as optional or required

Enabling and Setting up SSL Support

NOTE: A restart of the Sentry is required after setting or changing ANY SSL configurations. See *Performing a warm boot* on page 41 for more information.

Enabling or disabling SSL support:

The Set SSL command is used to enable or disable SSL support.

To enable or disable SSL support:

At the Sentry: prompt, type **set ssl**, followed by **enabled** or **disabled** and press **Enter**.

Setting SSL access level:

The Set SSL Access command is used to assign use of SSL as optional or required. The default access level is set to optional.

To change the access level:

At the Sentry: prompt, type **set ssl access**, followed **optional** or **required**, and press **Enter**.

Example

The following changes the access level to required:

```
Sentry: set ssl access required<Enter>
```

SSL Technical Specifications

Secure Socket Layer (SSL) version 3

Transport Layer Security (TLS) version 1 (RFC 2246)

SSL/TLS-enabled HTTPS server (RFC 2818)

Self-Signed X.509 Certificate version 3 (RFC 2459)

Asymmetric Cryptography:

1024-bit RSA Key Exchange

Symmetric Cryptography Ciphers:

TLS_RSA_WITH_AES_256_CBC_SHA

TLS_RSA_WITH_AES_128_CBC_SHA

TLS_RSA_WITH_3DES_EDE_CBC_SHA

TLS_RSA_WITH_DES_CBC_SHA

SSH

Secure Shell (SSH) version 2 enables secure network terminal sessions between a Sentry Remote Power Manager and a remote user over insecure network. SSH provides an encrypted terminal sessions with strong authentication of both the server and client, using public-key cryptography and is typically used as a replacement for unencrypted Telnet. In addition to enabling secure network terminal sessions to the Sentry for configuration and power management, the SSH session may be used for secure Pass-Thru connections to attached devices.

SSH requires the configuration and use of a client agent on the client PC. There are many freeware, shareware or for-purchase SSH clients available. Two examples are the freeware client PuTTY and the for-purchase client SecureCRT® by VanDyke® Software. For configuration and use of these clients, please refer to the applicable software documentation.

SSH Command Summary

Command	Description
Set SSH	Enables/disables SSH support
Set SSH Port	Sets the SSH server port number

Enabling and Setting up SSH Support

NOTE: A restart of the Sentry is required after setting or changing ANY SSH configurations. See *Performing a warm boot* on page 41 for more information.

Enabling or disabling SSH support:

The Set SSH command is used to enable or disable SSH support.

To enable or disable SSH support:

At the Sentry: prompt, type **set ssh**, followed by **enabled** or **disabled** and press **Enter**.

Changing the SSH server port:

With SSH support enabled, the SSH server watches and responds to requests on the default SSH port number 22. This port number may be changed using the Set SSH Port command.

To change the SSH port:

At the Sentry: prompt, type **set ssh port**, followed by the port number and press **Enter**.

Example

The following changes the SSH port number to 65535:

```
Sentry: set ssh port 65535<Enter>
```

SSH Technical Specifications

Secure Shell (SSH) version 2

Asymmetric Cryptography:

Diffie-Hellman DSA/DSS 512-1024 (random) bits per NIST specification

Symmetric Cryptography:

AES256-CBC	RIJNDAEL256-CBC	3DES-192-CBC
AES192-CBC	RIJNDAEL192-CBC	BLOWFISH-128-CBC
AES128-CBC	RIJNDAEL128-CBC	ARCFOUR-128

Message Integrity:

HMAC-SHA1-160	HMAC-SHA1-96
HMAC-MD5-128	HMAC-MD5-96

Authentication:

Username/Password

Session Channel Break Extension (for RS232 Break)

SNMP

The Sentry family of products supports the Simple Network Management Protocol (SNMP). This allows network management systems to use SNMP requests to retrieve information and control power for the individual outlets.

The Sentry includes an SNMP v2c agent supporting standard MIB I and MIB II objects. A private enterprise MIB extension (Sentry3 MIB) is also supported to provide remote power control.

See *SNMP* on page 19, for information on enabling and configuring SNMP.

NOTE: For security, SNMP support is disabled by default.

SNMP Command Summary

Command	Description
Set SNMP	Enables or disables SNMP support
Set SNMP Getcomm	Sets the 'get' community string
Set SNMP Setcomm	Sets the 'set' community string
Set SNMP Trapdest	Sets a destination IP address or hostname for traps
Set SNMP Traptime	Sets the delay for steady state condition traps
Set SNMP IPRestrict	Allows SNMP GET and SET requests from defined traps destinations only
Show SNMP	Displays all SNMP configuration information

MIB, OID and Support

The Sentry SNMP MIB and OID are available on the Server Technology website:

<ftp://ftp.servertech.com/pub/SNMP/sentry3>

Technical support is available 8:00AM to 5:00 PM Pacific Time, Monday-Friday.

For SNMP Support, email: mibmaster@servertech.com

Enabling and Setting up SNMP Support

Sentry SNMP support must be enabled and configured for access to Sentry3 MIB objects and generation of all Sentry3 traps.

Enabling/disabling SNMP support:

The Sentry SNMP command is used to enable or disable SNMP support.

To enable SNMP support:

At the Sentry: prompt, type **set snmp**, followed by **enabled** or **disabled** and press **Enter**.

NOTE: A restart of the Sentry is required after enabling or disabling SNMP support. See *Performing a warm boot* on page 41 for more information.

Setting trap destinations:

The Set SNMP Trapdest1 and Trapdest2 commands are used to set the IP addresses or hostname of SNMP management stations receiving all traps. Sentry supports a maximum of two trap destinations; one must be defined to enable trap generation.

To set the trap destination:

At the Sentry: prompt, type **set snmp, trapdest1** or **trapdest2**, the Ipaddress or hostname and press **Enter**.

Examples

The following sets the trap destination 1 to 64.42.31.208:

```
Sentry: set snmp trapdest1 64.42.31.208<Enter>
```

The following sets the trap destination 2 to snmp.servertech.com:

```
Sentry: set snmp trapdest2 snmp.servertech.com<Enter>
```

To reset the trap destination:

At the Sentry: prompt, type **set snmp, trapdest1** or **trapdest2, 0.0.0.0** and press **Enter**.

Setting the trap timer:

The Set Traptime command sets the timer period between repeated error-condition traps. The valid range for the timer period is 1 to 65535 (in seconds). The default value for the timer period is 60 seconds.

To set the trap timer:

At the Sentry: prompt, type **set traptime**, followed by the timer period and press **Enter**.

Example

The following sets the timer period to 180 seconds:

```
Sentry: set traptime 180<Enter>
```

Setting the Get/Set community strings:

Sentry supports two SNMP community strings that provide varying levels of access to objects defined in the Sentry3 MIB.

Community strings may be 1 to 24 characters.

Setcomm:

The Setcomm string provides read-write access to sentry3 MIB objects. The default Setcomm string is “private”

To set the Setcomm community string:

At the Sentry: prompt, type **set snmp setcomm**, followed by the string and press **Enter**.

Getcomm:

The Getcomm string provides read-only access to sentry3 MIB objects. The default Getcomm string is “public”.

To set the Getcomm community string:

At the Sentry: prompt, type **set snmp getcomm**, followed by the string and press **Enter**.

Setting SNMP IP Restrictions:

The Set SNMP IP Restrictions command supports SNMP Manager GET and SET requests to only be allowed from the IP addresses of the defined traps destinations.

To set SNMP IP Restrictions:

At the Sentry: prompt, type **set snmp iprestrict trapdests** and press **Enter**.

To remove SNMP IP Restrictions:

At the Sentry: prompt, type **set snmp iprestrict none** and press **Enter**.

Setting the SNMP SysName:

The Set SNMP SysName command is used to set the SNMP MIB-II SysName object.

To set the SysName object:

At the Sentry: prompt, type **set snmp sysname**, followed by the object name and press **Enter**.

Setting the SNMP SysLocation:

The Set SNMP SysName command is used to set the SNMP MIB-II SysLocation object.

To set the SysLocation object:

At the Sentry: prompt, type **set snmp syslocation**, followed by the object location and press **Enter**.

Setting the SNMP SysContact:

The Set SNMP SysName command is used to set the SNMP MIB-II SysLocation object.

To set the SysContact object:

At the Sentry: prompt, type **set snmp syscontact**, followed by the object contact and press **Enter**.

Setting the Trap community string:

The Set SNMP Trapcomm command is used to set the community string that is included with all generated traps. This string must be defined to enable trap generation.

The trap community string may be 1 to 24 characters.

The default Trapcomm string is “trap”.

To set the Trapcomm community string:

At the Sentry: prompt, type **set snmp trapcomm**, followed by the string and press **Enter**.

Displaying SNMP configuration information:

The Show SNMP command displays all SNMP configuration information.

- SNMP support status
- SNMP community strings
- Trap timer value
- Trap destinations

To display SNMP configuration information:

At the Sentry: prompt, type **show snmp** and press **Enter**.

Example

The following command displays the SNMP configuration information:

```
Sentry: show snmp<Enter>
SNMP Configuration
SNMP:                               Enabled
GET Community String:                public
SET Community String:                private
TRAP Community String:               trap
Error Trap Repeat Time (seconds):    180 seconds
Trap Destination 1:                  64.42.31.208
Trap Destination 2:                  snmp.servertech.com
IP Restrictions:                      Trap Destinations Only
SysName:                             No Name
SysLocation:                          No Location
SysContact:                           No Contact
```

SNMP Traps

The Intelligent IPM supports four types of SNMP traps. Traps are enabled at the Tower (T), Infeed (I), outlet (O), Environmental Monitor (E) or sensor (S) level.

Trap Summary

Name	Level(s)	Description
Status	T, I, O, E, S	Operational status change
Change	O	Control status change
Temp	S	Temperature is out of range
Humid	S	Relative Humidity is out of range

All traps include the Location of the Sentry as defined with the Set Location command.

Status trap

A Status trap is generated when an error condition occurs on a tower, infeed, Environmental Monitor or individual sensor. Status traps include the reported Status, the Location of the Sentry and identifier and name of the affected tower, infeed, outlet, environmental monitor or sensor.

Any error state generates a Status trap and triggers the trap timer. A new trap is generated at the end of every timer period until the Status returns to a non-error status. All status traps are enabled by default.

Tower Status traps

Status	Error	Description
Normal		Tower is working correctly
NoComm	x	Communication to the tower has been lost

Infeed Status traps

Status	Error	Description
On		Infeed is on
OffError	x	Infeed should be on but no current is sensed at the infeed
NoComm	x	Communication to the infeed has been lost

Outlet Status traps

Status	Error	Description
On		Outlet is on
Off		Outlet is off
OnWait		Outlet Status in transition
OffWait		Outlet Status in transition
OnError	x	Outlet should be off but current is sensed at the outlet
OffError	x	Outlet should be on but no current is sensed at the outlet
OffFuse	x	Outlet should be on but a blown fuse has been detected
NoComm	x	Communication to the outlet has been lost

Environmental Monitor Status traps

Status	Error	Description
Normal		Environmental Monitor is working correctly
NoComm	x	Communication to the Environmental Monitor has been lost

Temperature/Humidity Sensor Status traps

Status	Error	Description
Found		The sensor has been detected
NotFound		No sensor has been detected
Lost	x	Sensor initially detected but communication to the sensor has been lost
NoComm	x	Communication to the sensor has been lost

NOTE: Traps are generated according to a hierarchical architecture, for example, if an Tower Status enters a trap condition, only the Tower Status trap will be generated. Infeed, Outlet, Environmental Monitor or Sensor Status and Temp and Humid traps will be suppressed until the Tower Status returns to Normal.

Change trap

The Change trap is generated for all outlet status changes between any on/off conditions. Change traps include the outlet status, Location of the Sentry, and identifier and name of the affected outlet. For descriptions of the outlet status types, please refer to the prior table.

Temp Trap

The Temp trap is generated whenever the temperature on a temperature/humidity sensor is beyond preset thresholds. Temp traps include the reported temperature, temp status, Location of the Sentry, and identifier and name of the affected sensor.

Any error state generates a Temp trap and triggers the trap timer. A new trap is generated at the end of every timer period until the Temp returns to a non-error status.

Temp traps

Status	Error	Description
Normal		The sensor is working correctly and the temperature is within preset thresholds
NotFound		No sensor has been detected
Reading		Temp status currently being read
TempLow	x	Temperature at the sensor below preset low threshold
TempHigh	x	Temperature at the sensor exceeds preset high threshold
ReadError	x	Unable to read Temp status
Lost	x	Sensor initially detected but communication to the sensor has been lost
NoComm	x	Communication to the sensor has been lost

Humidity Trap

The Humidity trap is generated whenever the humidity on a temperature/humidity sensor is beyond preset thresholds. Humidity traps include the reported relative humidity, humidity status, Location of the Sentry, and identifier and name of the affected sensor.

Any error state generates a Humidity trap and triggers the trap timer. A new trap is generated at the end of every timer period until the Humidity returns to a non-error status.

Humidity traps

Status	Error	Description
Normal		The sensor is working correctly and the relative humidity is within preset thresholds
NotFound		No sensor has been detected
Reading		Humidity status currently being read
HumidLow	x	Relative humidity at the sensor below preset low threshold
HumidHigh	x	Relative humidity at the sensor exceeds preset high threshold
ReadError	x	Unable to read Humidity status
Lost	x	Sensor initially detected but communication to the sensor has been lost
NoComm	x	Communication to the sensor has been lost

Configuring Traps

SNMP Trap Command Summary

Command	Description
Set Trap Tower Status	Enables or disables the Tower Status trap
Set Trap Infeed Status	Enables or disables the Infeed Status trap off
Set Trap Outlet Change	Enables or disables the Outlet Change trap
Set Trap Outlet Status	Enables or disables the Outlet Status trap
Set Trap EM Status	Enables or disables the Environmental Monitor Status trap
Set Trap THS Status	Enables or disables a temperature/humidity sensor Status trap
Set Trap THS Temp	Enables or disables a temperature/humidity sensor Temp trap
Set Trap THS Temphigh	Sets a temperature/humidity sensor Temp trap high limit
Set Trap THS Templow	Sets a temperature/humidity sensor Temp trap low limit
Set Trap THS Humid	Enables or disables a temperature/humidity sensor Humid trap
Set Trap THS Humidhigh	Sets a temperature/humidity sensor Humid trap high limit
Set Trap THS Humidlow	Sets a temperature/humidity sensor Humid trap low limit
Show Traps	Displays trap configurations

Enabling or Disabling a Status trap:

The Set Trap ... Status command is used to enable or disable Status traps for a Tower, Infeed or Outlet.

To Enable or Disable a Status trap:

At the Sentry: prompt, type **set trap (tower, infeed, outlet, em or ths) status**, followed by the tower, infeed or outlet name, and **on** or **off**. Press **Enter**, or\

Type **set trap (tower, infeed, outlet, em or ths) Status all**, followed by **on** or **off** and press **Enter**.

Examples

The following command enables the Status trap for the first tower, using the tower's absolute name:

```
Sentry: set trap tower status .a on<Enter>
```

The following command enables the Status trap for the tower named Florida_HQ_1:

```
Sentry: set trap tower status Florida_HQ_1 on<Enter>
```

NOTE: Enabling lower hierarchical traps automatically enables traps of higher hierarchical value: i.e. enabling an Outlet Status trap automatically enables the Infeed and Tower Status traps for that outlet. Conversely, if a Tower Status trap is disabled, all associated Infeed Status & Load and Outlet Status traps will be disabled.

Enabling or Disabling a Change trap:

The Set Trap Outlet Change command is used to enable or disable an Outlet Change trap.

To Enable or Disable a Change trap:

At the Sentry: prompt, type **set trap outlet change**, followed by the outlet name and **on** or **off**. Press **Enter**, or

Type **set trap outlet change all**, followed by **on** or **off** and press **Enter**.

Example

The following command enables the Change trap for the third outlet on the first infeed of the second tower, using the outlet's absolute name:

```
Sentry: set trap outlet change .ba3 on<Enter>
```

Enabling or Disabling the Temp trap:

The Set Trap THS Temp command is used to enable or disable the Temp trap.

To Enable or Disable the Temp trap:

At the Sentry: prompt, type **set trap ths temp**, followed by the sensor name and **on** or **off**. Press **Enter**.

Example

The following command enables the Temp trap for the first temperature-humidity sensor:

```
Sentry: set trap ths temp .a1 on<Enter>
```

Setting the Temperature sensor threshold limits:

The Set Trap THS Templo and Set Trap THS Temphigh commands are used to set the lower and upper threshold limits for the Temperature sensor.

To set the Temperature threshold limits:

At the Sentry: prompt, type **set trap ths, templo** or **temphigh**, followed by the sensor name and a value from 0 to 127 in degrees Celsius. Press **Enter**.

Example

The following command sets the second temperature high threshold limit to 95:

```
Sentry: set trap ths temphigh .a2 95<Enter>
```

Enabling or Disabling the Humid trap:

The Set Trap THS Humid command is used to enable or disable the Humid trap.

To Enable or Disable the Humid trap:

At the Sentry: prompt, type **set trap ths humid**, followed by the sensor name and **on** or **off**. Press **Enter**.

Example

The following command enables the Humid trap for the first temperature-humidity sensor:

```
Sentry: set traps ths humid .a1 on<Enter>
```

Setting the Humidity sensor threshold limits:

The Set Trap THS Humidlow and Set Trap THS Humidhigh commands are used to set the lower and upper threshold limits for the Humidity sensor.

To set the Humidity threshold limits:

At the Sentry: prompt, type **set trap ths, humidlow** or **humidhigh**, followed by the sensor name and a value from 0 to 100 in percent relative humidity. Press **Enter**.

Example

The following command sets the first humidity sensor low threshold limit to 5:

```
Sentry: set trap ths humidlow .a1 5<Enter>
```

Displaying trap configuration information:

The Show Traps command displays information about all traps.

To display trap information:

At the Sentry: prompt, type **show traps** and press **Enter**.

Example

The following command requests trap configuration information:

```
Sentry: show traps <Enter>
Tower trap configuration:
  Tower      Tower      Status
  ID         Name       Trap
  .A         Florida_HQ_1  ON
More (Y/es N/o): y
Input feed trap configuration:
  Input      Input      Status
  Feed ID   Feed Name  Trap
  .AA       HQ_1_Infeed_A  ON
More (Y/es N/o): y
Outlet trap configuration:
  Outlet      Outlet      Change  Status
  ID          Name       Trap    Trap
  .AA1       DataServer_1  OFF    ON
  .AA2       WebServer_1  OFF    ON
More (Y/es N/o): y
Environmental Monitor .A trap configuration:
Name: Florida_HQ_1
Status Trap: ON
Temperature/Humidity Sensor .A1      Temperature/Humidity Sensor .A2
  Name: Temp_Humid_Sensor_A1          Name: T/H2_Florida_HQ_1
  Status Trap: ON                     Status Trap: ON
  Temp Trap: ON                       Temp Trap: ON
  Low: 0 Deg.C                        Low: 0 Deg.C
  High: 127 Deg.C                     High: 95 Deg.C
  Humid Trap: ON                      Humid Trap: ON
  Low: 5 % RH                         Low: 0 % RH
  High: 100 % RH                      High: 100 % RH
```

LDAP

The Sentry family of products supports Lightweight Directory Access Protocol (LDAP) Version 3. This support enables authentication with LDAP servers; user accounts do not need to be individually created locally on each Sentry device.

This allows administrators to pre-define and configure (in each Sentry product, and in the LDAP server) a set of necessary LDAP Groups, and access rights for each. User's access rights can then be assigned or revoked simply by making the user a member of one-or-more pre-defined Sentry LDAP Groups. User accounts can be added, deleted, or changed in the LDAP server without any changes needed on individual Sentry products.

Sentry LDAP support has been tested in the following environments:

- Microsoft Active Directory (MSAD)
- Novell eDirectory (eDir)
- OpenLDAP

LDAP Command Summary

Command	Description
Set Authorder	Specifies the authentication order for each new session attempt
Set LDAP	Enables/disables LDAP support
Set LDAP Host	Sets the IP address or hostname of the Directory Services server
Set LDAP Port	Sets the LDAP server port number
Set LDAP Bind	Specifies the LDAP bind request password type
Set LDAP BindDN	Specifies the user account Fully-Qualified Distinguished Name (FQDN) for binds
Set LDAP BindPW	Specifies the user account password for binds
Set LDAP GroupAttr	Specifies the user class distinguished name (DN) or names of groups a user is a member of
Set LDAP GroupType	Specifies the data type for the Set LDAP GroupAttr command
Set LDAP UseTLS	Enables/disables LDAP over TLS/SSL support
Set LDAP UserBaseDN	Sets the base distinguished name (DN) for the username search at login
Set LDAP UserFilter	Sets the filter used for the username search at login
Show LDAP	Displays LDAP configurations
Set DNS	Sets the IP address of the Domain Name server
Ping	Verifies proper DNS configuration by name resolution
Show Network	Displays network configuration information
Create LDAPGroup	Adds an LDAP group name
Remove LDAPGroup	Deletes an LDAP group name
Add GrouptoLDAP	Grants an LDAP group access to one or more groups
Add OutlettoLDAP	Grants an LDAP group access to one or all outlets
Add PorttoLDAP	Grants an LDAP group access to one or serial ports
Delete GroupfromLDAP	Removes access to one or more groups for an LDAP group
Delete OutlettoLDAP	Removes access to one or more outlets for an LDAP group
Delete PortfromLDAP	Removes access to one or more serial ports for an LDAP group
Set LDAPGroup Access	Sets the access level for an LDAP group
Set LDAPGroup Envmon	Grants or removes privileges to view input and environmental monitoring status
List LDAPGroup	Displays all accessible outlet/groups/ports for an LDAP group
List LDAPGroups	Displays privilege levels for all LDAP groups

Enabling and Setting up LDAP Support

There are a few configuration requirements for properly enabling and setting up LDAP support. Below is an overview of the minimum requirements.

Directory Services server configuration requirements:

1. Define at least one LDAP group.
2. Assign users to that LDAP group.

Sentry configuration requirements:

1. Enable LDAP support.
2. Define the IP address and domain component of at least one Directory Services server.
3. Set the LDAP bind request method being utilized by the Directory Services server.
4. Define the IP address of at least one DNS server.
5. Test DNS server configuration using Sentry 'ping' support.
6. Define at least one LDAP group and assign access rights for that group.

NOTE: LDAP group names on the Directory Service server and the Sentry must match.

Enabling and disabling LDAP support:

The Set LDAP command is used to enable or disable LDAP support.

To enable or disable LDAP support:

At the Sentry: prompt, type **set ldap**, followed by **enabled** or **disabled** and press **Enter**.

Setting the LDAP host address:

The Set LDAP Host command sets the TCP/IP address of the Directory Services server.

To set the LDAP host address:

At the Sentry: prompt, type **set ldap**, followed by **host1** or **host2** and the Directory Services server's IP address or hostname. Press **Enter**.

Examples

The following command sets the primary Directory Services server IP address to 98.76.54.32:

```
Sentry: set ldap host1 98.76.54.32<Enter>
```

The following command sets the secondary Directory Services server hostname to ldap.servertech.com:

```
Sentry: set ldap host2 ldap.servertech.com<Enter>
```

Changing the LDAP server port:

The Set LDAP port command sets the port to which the Sentry sends LDAP requests to on the previously defined LDAP server. The default port is 389.

To change the LDAP server port:

At the Sentry: prompt, type **set ldap port**, followed by the port number and press **Enter**.

Example

The following command sets the LDAP server port number to 8888:

```
Sentry: set ldap port 8888<Enter>
```

Enabling and disabling LDAP over TLS/SSL support:

The Set LDAP UseTLS command is used to enable or disable LDAP over TLS/SSL support.

To enable or disable LDAP over TLS/SSL support:

At the Sentry CDU: prompt, type **set ldap usetls**, followed by **yes** or **no** and press **Enter**.

NOTE: When LDAP Over TLS/SSL is enabled, MD5 binding is disabled.

Setting the LDAP bind password type:

The Set LDAP Bind command sets the password type used in the bind requests. The Sentry supports two LDAP bind methods – Simple and MD5.

The Simple method utilizes unencrypted delivery of a username-password over the network to the Active Directory server for authentication.

The MD5 digest method provides much stronger protection utilizing one-way encoded hash numbers, never placing the username-password on the network. For more information on MD5, see *Setting the HTTP authentication method*: on page 15.

NOTE: Windows 2000 is known only to support Simple binding. Windows 2003 supports both Simple and MD5 binding.

To set the bind password type:

At the Sentry: prompt, type **set ldap bind**, followed by **simple** or **md5** and press **Enter**.

NOTE: When MD5 binding is enabled, LDAP over TLS/SSL is disabled.

Setting the search bind Distinguished Name (DN):

The Set LDAP BindDN command is used to set the fully-qualified distinguished name (FQDN) for user accounts to bind with. This is required for directory services that do not support anonymous binds. This field is used ONLY with Simple Binds. Maximum string length is 124 characters.

NOTE: If left blank, then an anonymous bind will be attempted. This field is used ONLY with Simple binds.

To set the search bind DN:

At the Sentry: prompt, type **set ldap binddn**, and press **Enter**. At the following prompt, type the FQDN and press **Enter**.

Example

The following sets the FQDN for MSAD to 'cn=guest,cn=Users,dc=servertech,dc=com':

```
Sentry: set ldap binddn<Enter>
Enter Search Bind DN (Max characters 124):
cn=guest,cn=Users,dc=servertech,dc=com<Enter>
```

Setting the search bind Distinguished Name (DN) password:

The Set LDAP BindPW command is used to set the password for the user account specified in the Search Bind DN. Maximum password size is 20 characters.

To set the Bind Password DN:

At the Sentry: prompt, type **set ldap bindpw** and press **Enter**. At the following prompt, type the bind password and press **Enter**.

Setting the group membership attribute:

The Set LDAP GroupAttr command is used to specify the name of user class attributes that lists distinguished names (DN), or names of groups that a user is a member of. Maximum string length is 30 characters.

To set Group Membership Attribute:

At the Sentry: prompt, type **set ldap groupattr** and press **Enter**. At the following prompt, type the group membership attribute and press **Enter**.

Example

The following sets the group membership attribute for MSAD to 'memberof':

```
Sentry: set ldap groupattr<Enter>
Enter Group Member Attr (Max character 30):
memberof<Enter>
```

Setting the group membership value type:

The Set LDAP GroupType command is used to specify whether the values of Group Membership Attribute represent the Distinguished Name (DN) of a group or just the name of the group.

To set group membership value type:

At the Sentry: prompt, type **set ldap grouptype** followed by **DN or Name** and press **Enter**.

Example

The following sets group membership value to DN

```
Sentry: set ldap grouptype DN<Enter>
```

Setting the user search base Distinguished Name (DN):

The Set LDAP UserBaseDN command is used to set the base (DN) for the login username search. This is where the search will start, and will include all subtrees. Maximum size is 100 characters.

To set the user search base DN:

At the Sentry: prompt, type **set ldap userbasedn** and press **Enter**. At the following prompt, type the search base DN and press **Enter**.

Example

The following sets the DN user search base for MSAD to 'cn=Users,dc=servertech,dc=com':

```
Sentry: set ldap userbasedn<Enter>
Enter User Search Base DN (Max characters 100):
cn=Users,dc=servertech,dc=com<Enter>
```

Setting the user search filter:

The Set LDAP UserFilter command is used to set the search filter for the username entered at the login prompt.

The search filter must be entered within parenthesis and adhere to the following format:

(searchfilter=%s)

where 'searchfilter' is the name of the attribute in the user class which has a value that represents the user's login name. In this string, the '%s' will be replaced by the entered username. Maximum string length is 100 characters.

To set the user search filter:

At the Sentry: prompt, type **set ldap userfilter** and press **Enter**. At the following prompt, type the User Search Filter and press **Enter**.

Example

The following sets the user search filter for MSAD to 'samaccountname':

```
Sentry: set ldap userfilter<Enter>
Enter User Search Filter (Max characters 100):
(samaccountname=%s)<Enter>
```

Setting the authentication order:

The Set Authorder command sets the authentication order for remote authentication sessions. The Sentry supports two methods for authentication order - Remote -> Local and Remote Only.

The Remote -> Local method first attempts authentication with the Active Directory server and if unsuccessful with the local user database on the Sentry device.

The Remote Only method attempts authentication only with the Active Directory server and if unsuccessful, access is denied.

NOTE: With the Remote Only method, if authentication fails due to a communication failure with the Active Directory server automatic authentication fallback will occur to authenticate with the local user data base on the Sentry device.

To set the authentication order:

At the Sentry: prompt, type **set authorder**, followed by **remotelocal** or **remoteonly** and press **Enter**.

NOTE: Server Technology recommends NOT setting the authentication order to Remote Only until the LDAP has been fully configured and tested.

Displaying LDAP configuration information:

The Show LDAP command displays LDAP configuration information.

- Enabled-disabled status of LDAP support
- Directory Services server IP address and port
- Bind request password type and remote authentication order
- Search bind distinguished name and password
- User search base distinguished name and filter
- Group membership attribute and type

To display the LDAP configuration information:

At the Sentry: prompt, type **show ldap** and press **Enter**.

Example

The following command displays the LDAP configuration information:

```
Sentry: show ldap
LDAP Configuration
LDAP:          Enabled
Host 1:        98.76.54.32
Host 2:        ldap.servertech.com
Port:          8888
TLS/SSL:       Yes
Bind Type:     MD5
Auth Order:    Remote->Local
Search Bind
  DN:          cd=guest,cn=Users,dc=servertech,dc=com
  Password:    OpenSesame
User Search
  Base DN:     cn=Users,dc=servertech,dc=com
  Filter:      (samaccountname=%s)
Group Membership
  Attribute:   memberof
  Value Type:  DN
```

Setting the DNS IP address:

The Set DNS command sets the TCP/IP address of the Domain Name server (DNS).

NOTE: LDAP requires the definition of at least one Domain Name server.

To display the DNS configuration information, use the Show Network command as described on page 42.

To set the DNS IP address:

At the Sentry: prompt, type **set**, followed by **dns1** or **dns2** and the Domain Name server's IP address. Press **Enter**.

Example

The following command sets the primary Domain Name server IP address to 98.76.54.254:

```
Sentry: set dns1 98.76.54.254<Enter>
```

Verifying the DNS configuration:

The Ping command may be used to verify the configuration of the DNS IP address.

To verify the DNS configuration:

At the Sentry: prompt, type **ping**, followed by the domain component of the Directory Services server previously configured and press **Enter**.

Example

The following command verifies the DNS configuration:

```
Sentry: ping servertech.com
Pinging servertech.com [98.76.54.32] with 64 bytes of data:
Reply from 98.76.54.32: bytes=64 pseq=0 triptime=0
Reply from 98.76.54.32: bytes=64 pseq=1 triptime=0
Reply from 98.76.54.32: bytes=64 pseq=2 triptime=0
Reply from 98.76.54.32: bytes=64 pseq=3 triptime=0
Reply from 98.76.54.32: bytes=64 pseq=4 triptime=0
```

Configuring LDAP Groups

Creating an LDAP group:

The Create LDAPGroup command creates an LDAP group.

To create an LDAP group:

At the Sentry: prompt, type **create ldapgroup**, optionally followed by a 1-16 character group name (Spaces are not allowed, and LDAP group names are not case sensitive). Press **Enter**.

Example

The following command creates the LDAP group PowerUser:

```
Sentry: create ldapgroup PowerUser<Enter>
```

Removing an LDAP group:

The Remove LDAPGroup command removes an LDAP group.

To remove an LDAP group:

At the Sentry: prompt, type **remove ldapgroup**, optionally followed by a group name. Press **Enter**.

Setting LDAP group access level privileges:

The Set LDAPGroup Access command sets the access level privileges for an LDAP group. The Sentry has four defined access privilege levels; Admin, User, On-Only and View-Only. For more information on user access levels, see *Changing a user's access privilege level*: on page 17.

To set the access level privilege for an LDAP group :

At the Sentry: prompt, type **set ldapgroup access**, followed by **admin**, **user**, **ononly** or **viewonly**, optionally followed by a LDAP group name and press **Enter**.

Examples

The following command sets the LDAP group access level for LDAPAdmin to Admin:

```
Sentry: set ldapgroup access admin ldapadmin<Enter>
```

The following command sets the LDAP group access level for PowerUser to User:

```
Sentry: set ldapgroup access user poweruser<Enter>
```

Granting and removing input status viewing privileges :

The Set LDAPGroup Envmon command grants or removes input status viewing privileges to/from an LDAP group.

To grant or remove input status viewing privileges for an LDAP group:

At the Sentry: prompt, type **set ldapgroup envmon** followed by **on** or **off**, optionally followed by a group name and press **Enter**.

Example

The following command grants input status viewing privileges to the LDAP group PowerUser:

```
Sentry: set ldapgroup envmon on poweruser<Enter>
```

Displaying the LDAP access privilege levels:

The List LDAPGroups command displays all defined LDAP group with their access privilege level.

To display LDAP group access privilege levels:

At the Sentry: prompt, type **list ldapgroups** and press **Enter**.

Example

The following command displays all LDAP groups with their access privilege level:

```
Sentry: list ldapgroups<Enter>
LDAP          Access      Environmental
Group Name   Level        Monitoring
LDAPAdmin    Admin        Allowed
PowerUser     User         Allowed
User          On-Only     Not Allowed
Guest         View-Only   Not Allowed
```

Adding outlet access to an LDAP group:

The Add OutletToLDAP command grants an LDAP group access to one or all outlets. To grant access for more than one outlet, but not all outlets, you must use multiple Add OutletToLDAP commands.

To grant outlet access to an LDAP group:

At the Sentry: prompt, type **add outlettoldap**, optionally followed by an outlet name and a group name. Press **Enter**, or

Type **add outlettoldap all**, followed by a group name and press **Enter**.

Examples

The following commands grant the LDAP group PowerUser access to outlets A1 and Webserver_1:

```
Sentry:add outlettoldap .a1 poweruser<Enter>
Sentry:add outlettoldap WebServer_1 poweruser<Enter>
```

Deleting outlet access for an LDAP group:

The Delete OutletFromLDAP command removes an LDAP group's access to one or all outlets. You cannot remove access to any outlet for an administrative level group.

To delete outlet access for an LDAP group:

At the Sentry: prompt, type **delete outletfromldap**, optionally followed by an outlet name and a group name. Press **Enter**, or

Type **delete outletfromldap all**, followed by a group name and press **Enter**.

Adding outlet group access to an LDAP group:

The Add GroupToLDAP command grants an LDAP group access to an outlet group. To grant access for more than one outlet group, you must use multiple Add GroupToLDAP commands.

To grant outlet group access to an LDAP Group:

At the Sentry: prompt, type **add grouptoldap**, optionally followed by an outlet group name and an LDAP group name. Press **Enter**.

Examples

The following commands grant to LDAP group PowerUser access to the outlet groups ServerGroup_1 and ServerGroup_2:

```
Sentry:add grouptoldap servergroup_1 poweruser<Enter>
Sentry:add grouptoldap servergroup_2 poweruser<Enter>
```

Deleting outlet group access for an LDAP group:

The Delete GroupFromLDAP command removes an LDAP group's access to an outlet group. You cannot remove access to any group for an administrative level group.

To delete outlet group access for an LDAP group:

At the Sentry: prompt, type **delete groupfromldap**, optionally followed by an outlet group name and an LDAP group name. Press **Enter**.

Adding serial port access to an LDAP group:

The Add PortToLDAP command grants an LDAP group access to the serial port.

To grant serial port access to an LDAP group:

At the Sentry: prompt, type **add porttoldap console** and a group name. Press **Enter**.

Deleting serial port access for an LDAP group:

The Delete PortFromLDAP command removes an LDAP group's access to the serial port. You cannot remove access to the serial port for an administrative level group.

To delete serial port access for a user:

At the Sentry: prompt, type **delete portfromldap console** and a group name. Press **Enter**.

Displaying LDAP Group access:

The List LDAPGroup command displays all access rights for an LDAP group.

To display LDAP Group access:

At the Sentry: prompt, type **list ldapgroup**, optionally followed by a group name. Press **Enter**.

Example

The following command displays information about the LDAP group PowerUser:

```
Sentry: list ldapgroup poweruser<Enter>
Username: PowerUser
  Outlet  Outlet
  ID      Name
  .A1     DataServer_1
  .A2     WebServer_1
Groups:
  ServerGroup_1
  ServerGroup_2
More (Y/es N/o): Y
Ports:
  Port    Port
  ID      Name
  Console Console
```

Members of the PowerUser LDAP group may access the following outlets, outlet groups and serial ports: outlet A1 which has a descriptive name of DataServer_1, outlet A2 which has a descriptive name of WebServer_1, group ServerGroup_1 group ServerGroup_2 and Console serial port.

LDAP Technical Specifications

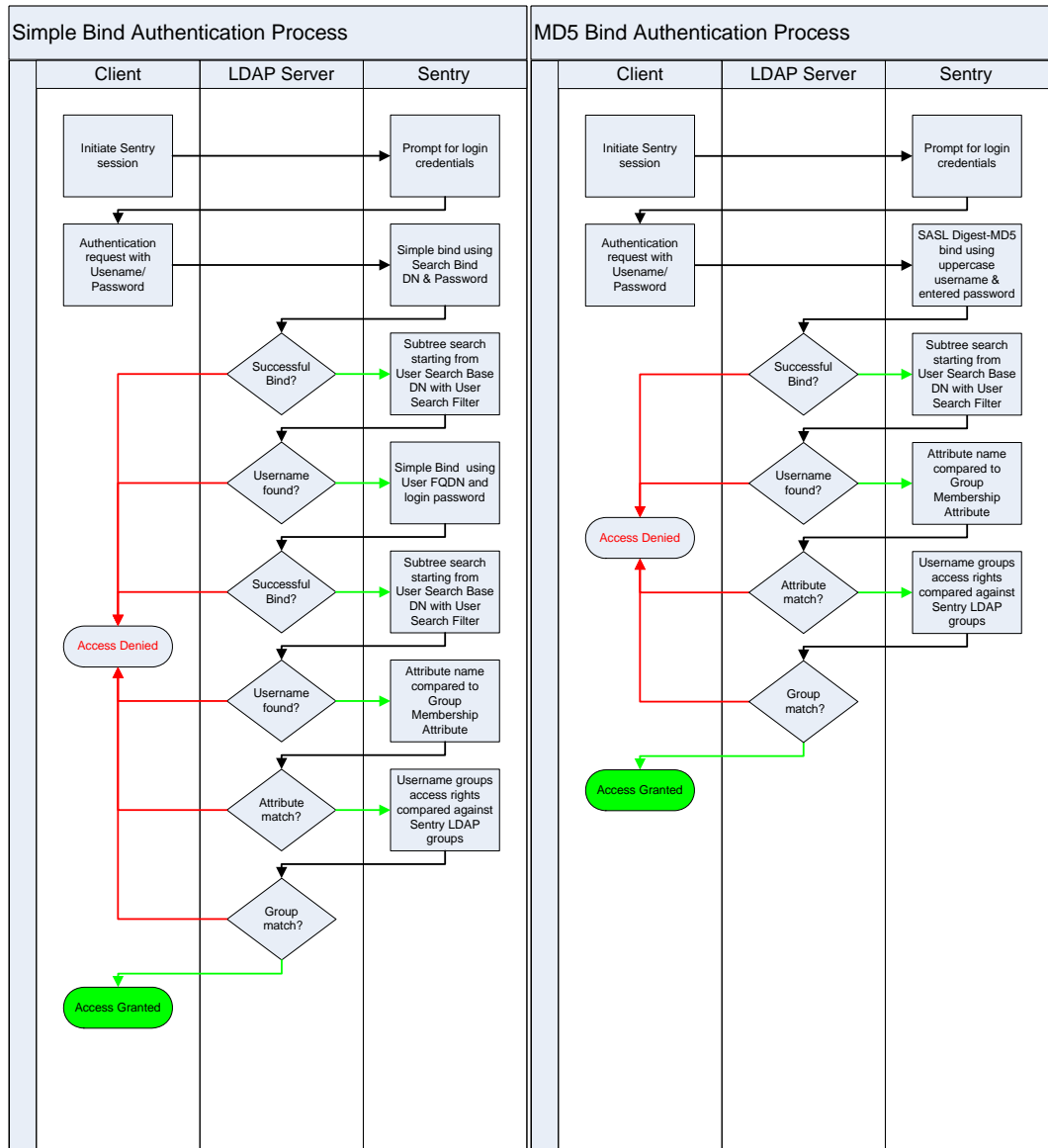

TACACS+

The Sentry family of products supports the Terminal Access Controller Access Control System (TACACS+) protocol. This enables authentication and authorization with a central TACACS+ server; user accounts do not need to be individually created locally on each Sentry device.

This allows administrators to pre-define and configure (in each Sentry product, and in the TACACS+ server) a set of necessary TACACS+ privilege levels, and user's access rights for each. User's access rights can then be assigned or revoked simply by making the user a member of one-or-more pre-defined Sentry TACACS+ privilege levels. User account rights can be added, deleted, or changed within TACACS+ without any changes needed on individual Sentry products.

The Sentry supports 16 different TACACS+ privilege levels; 15 are entirely configurable by the system administrator (1 is reserved for default Admin level access to all Sentry resources).

TACACS+ Command Summary

Command	Description
Set Authorder	Specifies the authentication order for each new session attempt
Set TACACS	Enables/disables SSL support
Set TACACS Host	Sets the IP address or hostname of the TACACS server
Set TACACS Key	Sets the TACACS encryption key
Set TACACS Port	Sets the TACACS server port number
Show TACACS	Displays TACACS configurations
Add GrouptoTACACS	Grants a TACACS account access to one or more groups
Add OutlettoTACACS	Grants a TACACS account access to one or all outlets
Add PorttoTACACS	Grants a TACACS account access to one or serial ports
Delete GroupfromTACACS	Removes access to one or more groups for a TACACS account
Delete OutlettoTACACS	Removes access to one or more outlets for a TACACS account
Delete PortfromTACACS	Removes access to one or more serial ports for a TACACS account
Set TacPriv Access	Sets the access level for a TACACS account
Set TacPriv Envmon	Grants or removes privileges to view input and environmental monitoring status
List TacPrivs	Displays access levels for all TACACS accounts
List TacPriv	Displays all accessible outlet/groups/ports for a TACACS account

Enabling and Setting up TACACS+ Support

There are a few configuration requirements for properly enabling and setting up TACACS+ support. Below is an overview of the minimum requirements:

1. Enable TACACS+ support.
2. Define the IP address and domain component of at least one TACACS+server.
3. Set the TACACS+ key configured on the supporting TACACS+server.

Enabling and disabling TACACS+ support:

The Set TACACS command is used to enable or disable TACACS+ support.

To enable or disable TACACS+ support:

At the Sentry: prompt, type **set tacacs**, followed by **enabled** or **disabled** and press **Enter**.

Setting the TACACS+ server address:

The Set TACACS Host command sets the IP address or hostname of the TACACS+ server.

To set the TACACS+ server address:

At the Sentry: prompt, type **set tacacs**, followed by **host1** or **host2** and the TACACS+ server's IP address or hostname. Press **Enter**.

Examples

The following command sets the primary TACACS+ server address to 98.76.54.32:

```
Sentry: set tacacs host1 98.76.54.32<Enter>
```

The following command sets the secondary TACACS+ server address to tacacs.servertech.com:

```
Sentry: set tacacs host2 tacacs.servertech.com<Enter>
```

Setting the TACACS+ encryption key:

The Set TACACS Key command sets the encryption key used to encrypt all data packets between the Sentry and the TACACS+ server. This key must match the key configured on the TACACS+ server.

To set the encryption key:

At the Sentry: prompt, type **set tacacs key** and press **Enter**.

At the TACACS+ Key: prompt, type a key of up to 60 alphanumeric and other keyboard characters (ASCII 32 to 126 decimal). Keys are case sensitive. Press **Enter**. To specify no password, press **Enter**.

At the Verify TACACS+ Key: prompt, retype the key. Press **Enter**. To verify no password, press **Enter** at the prompt.

Example

```
Sentry: set tacacs key<Enter>
TACACS+ Key: <Enter>
Verify TACACS+ Key: <Enter>
```

For security, key characters are not displayed.

NOTE: A key size of zero results in no encryption being applied which may not be supported by the TACACS+ server and is not recommended for a production environment.

Changing the TACACS port:

With TACACS support enabled, the Sentry sends TACACS requests to the default TACACS port number 49. This port number may be changed using the Set TACACS Port command.

To change the TACACS port:

At the Sentry: prompt, type **set tacacs port**, followed by the port number and press **Enter**.

Example

The following changes the TACACS port number to 50:

```
Sentry: set tacacs port 50<Enter>
```

Setting the authentication order:

The Set Authorder command sets the authentication order for remote authentication sessions. The Sentry supports two methods for authentication order - Remote -> Local and Remote Only.

The Remote -> Local method first attempts authentication with the TACACS+ server and if unsuccessful with the local user database on the Sentry device.

The Remote Only method attempts authentication only with the TACACS+ server and if unsuccessful, access is denied.

NOTE: With the Remote Only method, if authentication fails due to a communication failure with the TACACS+ server automatic authentication fallback will occur to authenticate with the local user data base on the Sentry device.

To set the authentication order:

At the Sentry: prompt, type **set authorder**, followed by **remotelocal** or **remoteonly** and press **Enter**.

NOTE: Server Technology recommends NOT setting the authentication order to Remote Only until the TACACS+ has been fully configured and tested.

Displaying TACACS+ configuration information:

The Show TACACS command displays TACACS+ configuration information.

To display the TACACS configuration information:

At the Sentry: prompt, type **show tacacs** and press **Enter**.

Example

The following command displays the TACACS configuration information:

```
Sentry: show tacacs<Enter>
TACACS+ Configuration
  TACACS+:      Enabled
  Host 1:      98.76.54.32
  Host 2:      tacacs.servertech.com
  Port:       50
  TACACS+ Key: (Set)
  Auth Order:  Remote->Local
```

Configuring TACACS+ Privilege Levels

Setting TACACS+ account access level privileges:

The Set TacPriv Access command sets the access level privileges for a TACACS+ account. The Sentry has four defined access privilege levels; Admin, User, On-Only and View-Only. For more information on user access levels, see *Changing a user's access privilege level:* on page 17.

To set the access level privilege for a TACACS+ account :

At the Sentry: prompt, type **set tacpriv access**, followed by **admin**, **user**, **ononly** or **viewonly**, optionally followed by a TACACS+ account number and press **Enter**.

Examples

The following command sets the TACACS+ account access level for account 14 to Admin:

```
Sentry: set tacpriv access admin 14<Enter>
```

The following command sets the TACACS+ account access level for account 5 to User:

```
Sentry: set tacpriv access user 5<Enter>
```

Granting and removing input status viewing privileges:

The Set TacPriv Envmon command grants or removes input status viewing privileges to/from a TACACS+ account.

To grant or remove input status viewing privileges for a TACACS+ account:

At the Sentry: prompt, type **set tacpriv envmon**, followed by **on** or **off**, optionally followed by a TACACS+ account number and press **Enter**.

Example

The following command grants input status viewing privileges to the TACACS+ account 5:

```
Sentry: set tacpriv envmon on 5<Enter>
```

Displaying the TACACS+ access privilege levels:

The List TacPrivs command displays all TACACS+ accounts with their access privilege levels.

To display TACACS+ account access privilege levels:

At the Sentry: prompt, type **list tacprivs** and press **Enter**.

Example

The following command displays all TACACS+ account with their access privilege level:

```
Sentry: list tacprivs<Enter>
TACACS      Access      Environmental
Account Name Level      Monitoring
TACAdmin    Admin      Allowed
PowerUser   User       Allowed
User        On-Only    Not Allowed
Guest       View-Only  Not Allowed
```

Adding outlet access to a TACACS+ account:

The Add OutletToTACACS command grants a TACACS+ account access to one or all outlets. To grant access for more than one outlet, but not all outlets, you must use multiple Add OutletToTACACS commands.

To grant outlet access to a TACACS+ account:

At the Sentry: prompt, type **add outlettotacacs**, optionally followed by an outlet name and a TACACS+ account number. Press **Enter**, or

Type **add outlettotacacs all**, followed by a TACACS+ account number and press **Enter**.

Examples

The following commands grant the a TACACS+ account 5 access to outlets A1 and Webserver_1:

```
Sentry:add outlettotacacs .a1 5<Enter>
Sentry:add outlettotacacs WebServer_1 5<Enter>
```

Deleting outlet access for a TACACS+ account:

The Delete OutletFromTACACS command removes a TACACS+ account's access to one or all outlets. You cannot remove access to any outlet for an administrative level account.

To delete outlet access for a TACACS+ account:

At the Sentry: prompt, type **delete outletfromtacacs**, optionally followed by an outlet name and a TACACS+ account number. Press **Enter**, or

Type **delete outletfromtacacs all**, followed by a TACACS+ account number and press **Enter**.

Adding outlet group access to a TACACS+ account:

The Add GroupToTACACS command grants a TACACS+ account access to an outlet group. To grant access for more than one outlet group, you must use multiple Add GroupToTACACS commands.

To grant outlet group access to a TACACS+ account:

At the Sentry: prompt, type **add grouptotacacs**, optionally followed by an outlet group name and a TACACS+ account number. Press **Enter**.

Examples

The following commands grants to a TACACS+ account number 5 access to the outlet groups ServerGroup_1 and ServerGroup_2:

```
Sentry:add grouptotacacs servergroup_1 5<Enter>
Sentry:add grouptotacacs servergroup_2 5<Enter>
```

Deleting outlet group access for a TACACS+ account:

The Delete GroupFromTACACS command removes a TACACS+ account's access to an outlet group. You cannot remove access to any group for an administrative level account.

To delete outlet group access for a TACACS+ account:

At the Sentry: prompt, type **delete groupfromtacacs**, optionally followed by a outlet group name and a TACACS+ account number. Press **Enter**.

Adding serial port access to a TACACS+ account:

The Add PortToTACACS command grants a TACACS+ account access to the serial port.

To grant serial port access to a TACACS+ account:

At the Sentry: prompt, type **add porttotacacs console** and a TACACS+ account number. Press **Enter**.

Deleting serial port access for a TACACS+ account:

The Delete PortFromTACACS command removes a TACACS+ account's access to the serial port. You cannot remove access to the serial port for an administrative level account.

To delete serial port access for a TACACS+ account:

At the Sentry: prompt, type **delete portfromtacacs console** and a TACACS+ account number. Press **Enter**.

Displaying TACACS account access:

The List TacPriv command displays all access rights for a TACACS+ account.

To display TACACS account access:

At the Sentry: prompt, type **list tacpriv**, optionally followed by a TACACS+ account. Press **Enter**.

Example

The following command displays information about the TACACS+ account 1:

```
Sentry: list tacpriv 1<Enter>
TACACS+ Privilege Level: 1
  Outlet  Outlet
  ID      Name
  .A1     DataServer_1
  .A2     WebServer_1
Groups:
  ServerGroup_1
  ServerGroup_2
More (Y/es N/o): Y
Ports:
  Port ID  Port Name
  Console  Console
```

Members of the TACACS privilege level 1 account may access the following outlets, outlet groups and serial ports: outlet A1 which has a descriptive name of DataServer_1, outlet A2 which has a descriptive name of WebServer_1, group ServerGroup_1 group ServerGroup_2 and Console serial port.

TACACS+ Technical Specifications

Authentication START Packet includes:

```
action = 1 (TAC_PLUS_AUTHEN_LOGIN)
priv_lvl = 0 (TAC_PLUS_PRIV_LVL_MIN)
authen_type = 1 (TAC_PLUS_AUTHEN_TYPE_ASCII)
service = 1 (TAC_PLUS_AUTHEN_SVC_LOGIN)
user = (entered username)
port = (access path into the Sentry)
rem_addr = 'Sentry3_XXXXXX' (XXXXXX is last six digits of MAC address)
data = "" (null)
```

NOTE: The password is sent in a CONTINUE packet.

Authorization REQUEST Packet includes:

```
authen_method = 6 (TAC_PLUS_AUTHEN_METH_TACACSPLUS)
priv_lvl = 0 (TAC_PLUS_PRIV_LVL_MIN)
authen_type = 1 (TAC_PLUS_AUTHEN_TYPE_ASCII)
authen_service = 1 (TAC_PLUS_AUTHEN_SVC_LOGIN)
user = (entered username)
port = (access path into the Sentry)
rem_addr = 'Sentry3_XXXXXX' (XXXXXX is last six digits of Ethernet MAC address)
service = 'shell' (for exec)
cmd = "" (null)
```

NOTE: The access paths into the Sentry which support TACACS+ are 'Console', 'Telnet', 'SSH', 'HTTP' and 'HTTPS'. In the case of 'Console' and 'Modem', an administrator is allowed to rename these ports in which case the assigned name is used.

Logging

The Sentry family of products supports logging of system events both internally and externally. An internal log of more than 4000 events is automatically maintained and is reviewable by administrative users. For permanent/long-term log storage, Sentry supports the Syslog protocol. And for immediate notification, Sentry supports Email notifications.

Log entries include a sequential entry number, a date/time stamp and an event message. The event message is preceded with a message 'type' heading and if the event is tied to a user, the username will be included.

NOTE: For date/time stamp support, SNTP server support must be configured. For information on SNTP, see page 18.

The Sentry supports the following event message headers:

- AUTH: All authentication attempts.
- POWER: All power state change requests.
- CONFIG: All system configuration changes.
- EVENT: All general system events. Example: over/under threshold event.

Internal System Log

The internal system log is stored in the local memory and has support for up to 4097 continuously aging entries. The internal system log is only available to administrative users. For instructions on reviewing the internal log, see page 23.

Syslog

The Sentry's Syslog support is RFC3164-compliant and enables off-Sentry viewing and storage of log messages. The Sentry supports external logging to up to two Syslog servers.

Syslog Command Summary

Command	Description
Set Syslog HostIP	Sets the IP address of the Syslog server
Set Syslog Port	Sets the Syslog server port number
Show Syslog	Displays all Syslog configuration information

Setting the Syslog server IP address:

The Set Syslog HostIP command sets the TCP/IP address of the Syslog server.

To set the Syslog server IP address:

At the Sentry: prompt, type **set syslog**, followed by **hostip1** or **hostip2** and the Syslog server's IP address. Press **Enter**.

Example

The following command sets the primary Syslog server IP address to 56.47.38.29:

```
Sentry: set syslog hostip1 56.47.38.29<Enter>
```

Changing the Syslog server port:

With Syslog support enabled, the Syslog server watches and responds to requests on the default Syslog port number 514. This port number may be changed using the Set Syslog Port command.

To change the Syslog port:

At the Sentry: prompt, type **set syslog port**, followed by the port number and press **Enter**.

Example

The following changes the Syslog port number to 411:

```
Sentry: set syslog port 411<Enter>
```

Displaying Syslog configuration information:

The Show Syslog command displays Syslog configuration information.

To display the Syslog configuration information:

At the Sentry: prompt, type **show syslog** and press **Enter**.

Example

The following command displays the Syslog configuration information:

```
Sentry: show syslog<Enter>
SYSLOG Configuration
  Primary Syslog Server IP Address:    56.47.38.29
  Secondary Syslog Server IP Address:  0.0.0.0
  Syslog Server Port:                  411
```

Email

Email Command Summary

Command	Description
Set Email	Enables or disables Email notification support
Set Email SMTP Host	Sets the SMTP Host IP address or hostname
Set Email SMTP Port	Sets the SMTP server port number
Set Email From	Sets the email 'From' address
Set Email PrimaryTo	Sets the primary recipient email address
Set Email SecondaryTo	Sets the secondary recipient email address
Set Email Event	Enables or disables notification of general system events
Set Email Auth	Enables or disables notification of all authentication attempts
Set Email Power	Enables or disables notification of power state change requests
Set Email Config	Enables or disables notification of configuration changes
Show Email	Displays all Email configuration information

Enabling or disabling Email notification Support:

The Set Email command enables or disables Email notification support.

To enable or disable Email notification support:

At the Sentry: prompt, type **set email**, followed by **enabled** or **disabled** and press **Enter**.

Setting the SMTP server address:

The Set Email Host command sets the IP address or hostname of the SMTP server.

To set the SMTP server address:

At the Sentry: prompt, type **set email smtp host**, followed by the SMTP server's IP address or hostname and press **Enter**.

Examples

The following command sets the SMTP server address to 55.55.55.55:

```
Sentry: set email smtp 55.55.55.55<Enter>
```

The following command sets the SMTP server address to email.servertech.com:

```
Sentry: set email smtp email.servertech.com<Enter>
```

Changing the SMTP server port:

With SMTP support enabled, the Sentry sends SMTP requests to the default SMTP port number 25. This port number may be changed using the Set Email SMTP Port command.

To change the TACACS port:

At the Sentry: prompt, type **set email smtp port**, followed by the port number and press **Enter**.

Example

The following changes the SMTP port number to 5555:

```
Sentry: set email smtp port 5555<Enter>
```

Setting the 'From' email address:

The Set Email From command sets the 'from' email address. By default, this is set to 'Sentry3_' plus the last three octets of the unit's MAC address. Example: 'Sentry3_510c90@'

To set the 'From' email address:

At the Sentry: prompt, type **set email from**, followed by the originating email address and press **Enter**.

Example

The following command sets the 'from' email address to Rack14CDU1@servertech.com:

```
Sentry: set email from Rack14CDU1@servertech.com<Enter>
```

Setting the 'To' email address:

The Set Email PrimaryTo and Set Email SecondaryTo commands set the recipient email addresses.

To set the 'To' email address:

At the Sentry: prompt, type **set email**, followed by **primaryto** or **secondaryto** and the destination email address. Press **Enter**.

Examples

The following command sets the primary 'to' email address to DayAdmin@servertech.com:

```
Sentry: set email primaryto DayAdmin@servertech.com<Enter>
```

The following command sets the secondary 'to' email address to NiteAdmin@servertech.com:

```
Sentry: set email secondaryto NiteAdmin@servertech.com<Enter>
```

Enabling or disabling event notification types:

The Set Email Event, Set Email Auth, Set Email Power and Set Email Config commands enable or disable email notification of the event types as described on page 73.

To enable or disable event notification types:

At the Sentry: prompt, type **set email**, followed by **event**, **auth**, **power** or **config** and **enabled** or **disabled**. Press **Enter**.

Examples

The following command sets the enables email notification general system events:

```
Sentry: set email event enabled<Enter>
```

The following command sets the disables email notification authentications attempts:

```
Sentry: set email auth disable<Enter>
```

Displaying Email configuration information:

The Show Email command displays Email configuration information.

To display the Email configuration information:

At the Sentry: prompt, type **show email** and press **Enter**.

Example

The following command displays the Email configuration information:

```
Sentry: show email
  Email Configuration
    Email Notifications:      Enabled
    SMTP Host:                email.servertech.com
    SMTP Port:                5555
    'From' Address:           Rack14CDU1@servertech.com
    Primary 'Send To' Address: DayAdmin@servertech.com
    Secondary 'Send To' Address: NiteAdmin@servertech.com
    Include EVENT Messages:   Enabled
    Include AUTH Messages:    Disabled
    Include POWER Messages:   Disabled
    Include CONFIG Messages:  Disabled
```

Upload/Download

The Sentry family of product supports the ability to upload and download system configurations using a standard FTP client. This feature enables for backup and restoration of system configuration as well as upload of 'template' configurations to ease large initial equipment deployments.

Upload/Download Command Summary

Command	Description
Set FTP Server	Enables or disables the FTP server
Show FTP	Displays FTP configuration information

Sentry Integrated FTP Server

The Sentry supports an integrated FTP Server which must be enabled for Upload/Download support. The Sentry FTP Server supports a single user at a time. Once an administrative user has authenticated with the Sentry FTP Server, standard FTP client commands may be used to upload or download Sentry configurations.

NOTE: The integrated FTP Server does NOT support web browser FTP file transfers. A non-web-browser is required for all Upload/Download requests.

Enabling and disabling the FTP server:

The Set FTP Server command is used to enable or disable the integrated FTP server.

To enable or disable the FTP server:

At the Sentry: prompt, type **set ftp server**, followed by **enabled** or **disabled** and press **Enter**.

FTP Configuration Files

The Sentry FTP server supports upload/download of two configuration files: CONFIG.BIN and NETWORK.INI. These files may be uploaded or downloaded using FTP PUT and GET operations.

- CONFIG.BIN This file contains the entire configuration of the Sentry excluding TCP/IP settings, serial/factory-only configurations, the x.509 certificate (SSL) and SSH keys. This file is encoded to keep all data (including usernames, passwords etc.) out of plain view. **This file is NOT editable.**
- FTP.INI This file contains only the FTP settings (FTP Host, username, password, filepath, filename and automatic updates support). This file is user readable and editable 'plain text' file.
- NETWORK.INI This file contains only the TCP/IP settings (IP address, subnet mask, gateway, DNS1 and DNS2). This file is user readable and editable 'plain text' file.
- SNTP.INI This file contains only the SNTP settings (SNTP Hosts and GMT offset). This file is user readable and editable 'plain text' file.

NOTE: The CONFIG.BIN file while *encoded* is not encrypted and susceptible to decoding using simple tools. Server Technology recommends the secure storage of CONFIG.BIN backup images.

Upload/Download Process

GETting a configuration file (Download):

1. Open the FTP client.
*In a Windows environment, in the Run window type **ftp** and press **Enter**.*
2. At the prompt, type **open**, followed by the IP address of the Sentry and press **Enter**.
FTP> open 12.34.56.78<Enter>
3. Authenticate with the appropriate administrative username and password.
4. At the prompt, type **get**, followed by the filename and press **Enter**.
FTP> get config.bin<Enter>
5. At the prompt, type **close** to close the connection to the Sentry.
FTP> close

PUTting a configuration file (Upload):

NOTE: Uploading the CONFIG.BIN file takes considerably longer than the NETWORK.INI file. When uploading both, Server Technology recommends uploading the NETWORK.INI file first.

1. Open the FTP client.
*In a Windows environment, in the Run window type **ftp** and press **Enter**.*
2. At the prompt, type **open**, followed by the IP address of the Sentry and press **Enter**.
FTP> open 12.34.56.78<Enter>
3. Authenticate with the appropriate administrative username and password.
4. At the prompt, type **put**, followed by the filename and press **Enter**.
FTP> put network.ini<Enter>
5. At the prompt, type **close** to close the connection to the Sentry and force a restart of the device.
FTP> close

Chapter 5: Appendices

Appendix A: Resetting to Factory Defaults

You may reset the non-volatile RAM that stores all configurable options. This clears all administrator-editable fields and resets all command line configurable options to their default values, including all user accounts.

You may reset the unit to factory defaults from the command line or the HTML interface, or by pressing the reset button. You must have administrator-level privileges to issue the command. Using the reset button may be necessary when a forgotten password prevents administrator login. Each of the methods updates the current working configuration to the factory defaults.

NOTE: Resetting the unit resets all TCP/IP and Telnet/Web configurations. Reconfiguring the TCP/IP and Telnet/web settings will be required.

To reset to factory defaults from the HTML interface

On the Restart page in the Tools section of the HTML interface, select **Restart and reset to factory defaults** from the drop-down menu and press **Apply**.

To reset to factory defaults from the command line

At the Sentry: prompt, type **restart factory** and press **Enter**.

To reset to factory defaults using the reset button

Locate the recessed reset button directly beside the Serial & Ethernet ports. You will need a non-conductive, non-metallic tool that fits inside the recess.

NOTE: This method will NOT work if the reset button has been disabled by the administrator.

Insert the tool in the recess, then depress and hold the reset button for at least ten seconds.

NOTE: If the reset button is depressed and held for more than 15 seconds, the reset will abort.

Appendix B: Uploading Firmware

You may upload new versions of firmware using File Transfer Protocol (FTP). This allows access to new firmware releases for firmware improvements and new features additions.

NOTE: To begin an FTP upload session, you must first configure the FTP Host address, username/password, filename and filepath. For information on configuring the FTP settings required for firmware upload see Chapter 3: Operations.

You may initiate an FTP upload session by issuing a command or from the HTML interface. You must have administrator-level privileges to initiate an upload.

To initiate an FTP upload session from the HTML interface

On the Restart page in the Tools section of the HTML interface, select **Restart and upload firmware via FTP** from the drop-down menu and press **Apply**.

Upon issuing this command the unit will restart and upload the firmware file specified with the FTP Filename command from the previously configured FTP Host. See *FTP Administration* in Chapter 3: for more information.

To initiate an FTP upload session from the command line

The Restart FTPLoad command initiates an upload of firmware. Upon issuing this command the unit will restart and upload the firmware file specified with the FTP Filename command from the previously configured FTP Host. See *FTP Administration* in Chapter 3: for more information.

To initiate an FTP firmware upload session:

At the Sentry: prompt, type **restart ftpload** and press **Enter**.

Appendix C: Technical Specifications

Domestic Models

Model	Rated Voltage	Input Cordset and Plug (10')	Outlets
CW-2H1-C20	100-120V 50/60Hz	IEC 60320 C20 ¹	2 NEMA 5-20R
CW-2H2-C20	208-240V 60Hz	IEC 60320 C20 ¹	2 IEC 60320 C13

International Models

Model	Rated Voltage	Input Cordset and Plug (10')	Outlets
CW-2H2-C20	230V 50/60Hz	IEC 60320 C20 ¹	2 IEC 60320 C13

¹ Input cordset selected at time of purchase

Power Ratings

Model <i>Modele</i> Modell	Input Current Ratings ¹ <i>L'indice du courant d'entrée</i> Eingangsstromstärke		Output Current Ratings <i>L'indice du courant de sortie</i> Ausgangsstromstärke		
	Voltage <i>Tension</i> Spannung	Current <i>Courant</i> Strom	Voltage <i>Tension</i> Spannung	Outlet <i>Prise</i> Anschlussstelle	Total <i>Total</i> Insgesamt
Cx-2H1-C20	100-120V 50/60Hz	16	100-120V 50/60Hz	16	16
Cx-2H2-C20	208-240V 60Hz	16	208-240V 60Hz	12	16
	230V 50/60Hz	16	230V 50/60Hz	10	16

¹ All current ratings are in amperes. *Tous les indices de courant sont en ampères.* Alle Angaben der Stromstärke erfolgen in Ampere.

Physical Specifications

	Operating	Storage
Temperature	32° to 104° F (0° to 40° C)	-40° to 185° F (-40° to 85° C)
Elevation(above MSL)	0 to 10,000 ft (0 to 3000m)	0 to 50,000 ft (0 to 15000m)
Relative Humidity	10 to 90%, non-condensing	10 to 90%, non-condensing
	Dimensions (H x W x D)	Weight
CW-2Hx	1.75 x 6.0 x 5.5 in. (45 x 152 x 140 mm)	2.2 lbs (1.0 kg)

Data Connections

RS-232 port

Intelligent IPMs are equipped standard with an RJ45 DTE RS-232c serial port. This connector may be used for direct local access or from other serial devices such as a terminal server. An RJ45 crossover cable is provided for connection to an RJ45 DCE serial port.

Pin	DTE Signal Name		Input/Output
1	Request to Send	RTS	Output
2	Data Terminal Ready	DTR	Output
3	Transmit Data	TD	Output
4	Signal Ground		
5	Signal Ground		
6	Receive Data	RD	Input
7	Data Set Ready	DSR	Input
8	Clear to Send	CTS	Input

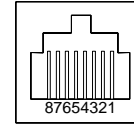

RJ45 to DB9F serial port adapter

Additionally, an RJ45 to DB9F serial port adapter is provided for use in conjunction with the RJ45 crossover cable to connect to a PC DB9M DCE serial port. The adapter pinouts below reflect use of the adapter with the provided RJ45 crossover cable.

Pin	DCE Signal Name		Input/Output
1			
2	Receive Data	RD	Output
3	Transmit Data	TD	Input
4	Data Terminal Ready	DTR	Input
5	Signal Ground		
6	Data Set Ready	DSR	Output
7	Request to Send	RTS	Input
8	Clear to Send	CTS	Output

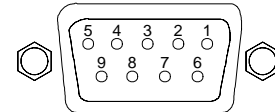

LED Indicators

Outlets

Units are equipped with a status LED for each power receptacle. A lit/on LED indicates that power is being supplied at the port and a darkened/off LED indicates that there is no power at the port.

Regulatory Compliance

Product Safety

Units have been safety tested and certified to the following standards:

- USA/Canada UL 60950:2003 and CAN/CSA 22.2 No. 60950-1-03
- European Union EN60950-1:2001

This product is also designed for Norwegian IT power system with phase-to phase voltage 230V.

USA Notification

Note: This equipment has been tested and found to comply with the limits for a Class A digital device, pursuant to part 15 of the FCC Rules. These limits are designed to provide reasonable protection against harmful interference when the equipment is operated in a commercial environment. This equipment generates, uses, and can radiate radio frequency energy and, if not installed and used in accordance with the instruction manual, may cause harmful interference to radio communications. Operation of this equipment in a residential area is likely to cause harmful interference in which case the user will be required to correct the interference at the user's own expense.

Modifications not expressly approved by the manufacturer could void the user's authority to operated the equipment under FCC rules.

Canadian Notification

This Class A digital apparatus complies meets all requirements of the Canadian Interference-Causing Equipment Regulations.

Cet appareil numérique de la classe A respecte toutes les exigences du Règlement sur le matériel brouilleur du Canada.

European Union Notification

Products with the CE Marking comply with both the EMC Directive (89/336/EEC) and the Low Voltage Directive (73/23/EEC) issued by the Commission of the European Community.

Compliance with these directives implies conformity to the following European Norms:

- EN55022 Electromagnetic Interference
- EN55024 Electromagnetic Immunity
- EN60950-1 Product Safety
- EN61000-3 Harmonics and Flicker



Products with the following mark comply with the RoHS Directive (2002/95/EC) issued by the Commission of the European Community.

Japanese Notification

この装置は、情報処理装置等電波障害自主規制協議会（VCCI）の基準に基づくクラスA情報技術装置です。この装置を家庭環境で使用すると電波妨害を引き起こすことがあります。この場合には使用者が適切な対策を講ずるよう要求されることがあります。

Recycling



Server Technology Inc. encourages the recycling of its products. Disposal facilities, environmental conditions and regulations vary across local, state and country jurisdictions, so Server Technology encourages consultation with qualified professional and applicable regulations and authorities within your region to ensure proper disposal.

Waste Electrical and Electronic Equipment (WEEE)



In the European Union, this label indicates that this product should not be disposed of with household waste. It should be deposited at an appropriate facility to enable recovery and recycling.

For information on how to recycle this product responsibly in your country, please visit:

www.servertech.com/support/recycling.

Appendix D: Warranty, Product Registration and Support

Warranty

For [Server Technology Warranty](#) information, please see our website.

Product Registration

Registration is your key to special offers and services reserved for Registered Users.

- Excellent Technical Support Services
- Special Update and Upgrade Programs
- Warranty Protection
- Extended Warranty Service
- New Product Information

[Register your products online today!](#)

Technical Support



Experience Server Technology's FREE **SMARTER** Technical Support - [Learn more...](#)

Server Technology understands that there are often questions when installing and/or using a new product. Free Technical Support is provided from 6:00 AM to 7:00 PM, Monday-Friday, Pacific Time.

Server Technology, Inc.

1040 Sandhill Drive

Tel: 775.284.2000

Web: www.servertech.com

Reno, Nevada 89521 USA

Fax: 775.284.2065

Email: support@servertech.com

Return Merchandise Authorization

If you have a unit that is not functioning properly and is in need of technical assistance or repair:

Please review Server Technology's [Return Merchandise Authorization](#) process on our website.



Server Technology

HEADQUARTERS – NORTH AMERICA

Server Technology, Inc.

1040 Sandhill Drive
Reno, NV 89521
United States
+1.775.284.2000 Tel
+1.775.284.2065 Fax
sales@servertech.com
www.servertech.com
www.servertechblog.com

EMEA

Server Technology Intl

Sienna Court
The Broadway
Maidenhead
Berkshire
SL6 1NJ
United Kingdom
+44 (0) 1628 509503 Tel
+44 (0) 1628 509100 Fax
salesintl@servertech.com

APAC

Server Technology, Inc.

Singapore
+65 (0) 6829 7008 Tel
+65 (0) 6234 4574 Fax
salesintl@servertech.com