



Smart Cabinet Distribution Unit

- CSG-24V2/E
- CSG-24V4 230/400V
- CSG-24V5 240/415V
- CSG-24VD/VY 20/30A
- CSG-24VD/Y 50/60A

Installation and Operations Manual



Instructions

This symbol is intended to alert the user to the presence of important operating and maintenance (servicing) instructions in the literature accompanying the appliance.



Dangerous Voltage

This symbol is intended to alert the user to the presence of un-insulated dangerous voltage within the product's enclosure that may be of sufficient magnitude to constitute a risk of electric shock to persons.



Protective Grounding Terminal

This symbol indicates a terminal that must be connected to earth ground prior to making any other connections to the equipment.

Life-Support Policy

As a general policy, Server Technology does not recommend the use of any of its products in the following situations:

- life-support applications where failure or malfunction of the Server Technology product can be reasonably expected to cause failure of the life-support device or to significantly affect its safety or effectiveness.
- direct patient care.

Server Technology will not knowingly sell its products for use in such applications unless it receives in writing assurances satisfactory to Server Technology that:

- the risks of injury or damage have been minimized,
- the customer assumes all such risks, and
- the liability of Server Technology is adequately protected under the circumstances.

The term life-support device includes but is not limited to neonatal oxygen analyzers, nerve stimulators (whether used for anesthesia, pain relief or other purposes), auto-transfusion devices, blood pumps, defibrillators, arrhythmia detectors and alarms, pacemakers, hemodialysis systems, peritoneal dialysis systems, neonatal ventilator incubators, ventilators (for adults or infants), anesthesia ventilators, infusion pumps, and any other devices designated as "critical" by the U.S. FDA.

Notices

301-0436-1 Rev B (020912)

Copyright © 2005-2012 Server Technology, Inc. All rights reserved.

1040 Sandhill Drive

Reno, Nevada 89521 USA

All Rights Reserved

This publication is protected by copyright and all rights are reserved. No part of it may be reproduced or transmitted by any means or in any form, without prior consent in writing from Server Technology.

The information in this document has been carefully checked and is believed to be accurate. However, changes are made periodically. These changes are incorporated in newer publication editions. Server Technology may improve and/or change products described in this publication at any time. Due to continuing system improvements, Server Technology is not responsible for inaccurate information which may appear in this manual. For the latest product updates, consult the Server Technology web site at www.servertech.com. In no event will Server Technology be liable for direct, indirect, special, exemplary, incidental or consequential damages resulting from any defect or omission in this document, even if advised of the possibility of such damages.

In the interest of continued product development, Server Technology reserves the right to make improvements in this document and the products it describes at any time, without notices or obligation.

The Globe logo is a trademark of Server Technology, Inc., registered in the US. Use of the logos for commercial purposes without the prior written consent of Server Technology may constitute trademark infringement and unfair competition in violation of federal and state laws.

Server Technology, the Globe logo, Smart CDU, and CDU are trademarks of Server Technology, Inc., registered in the US.

Sentry, POPS, the POPS logo, Cabinet Distribution Unit, Smart CDU, Environmental Monitor, and **SMARTER** Technical Support are trademarks of Server Technology, Inc.

Other trademarks and trade names may be used in this document to refer to either the entities claiming the marks and names or their products. Server Technology, Inc. disclaims any proprietary interest in trademarks and trade names other than its own.



Please Recycle

Shipping materials are recyclable. Please save them for later use, or dispose of them appropriately.

Table of Contents

CHAPTER 1: INTRODUCTION	4
Quick Start Guide	4
Technical Support.....	4
Equipment Overview	5
CHAPTER 2: INSTALLATION	6
Standard Accessories	6
Optional Accessories	6
Additional Required Items.....	6
Safety Precautions	7
Installing the Power Input Retention Bracket	8
Mounting	8
Attaching the Expansion Module.....	9
Connecting to the Power Source.....	9
Connecting Devices	9
Connecting the Sensors.....	9
Connecting to the Unit.....	9
CHAPTER 3: OPERATIONS	11
Interfaces	12
Web Interface.....	12
Command Line Interface	42
CHAPTER 4: ADVANCED OPERATIONS	69
SSL	70
SSH.....	71
SNMP/Thresholds.....	73
LDAP.....	81
TACACS+	89
RADIUS	93
Logging.....	97
Upload/Download.....	101
CHAPTER 5: APPENDICES	103
Appendix A: Resetting to Factory Defaults	103
Appendix B: Uploading Firmware.....	104
Appendix C: Technical Specifications.....	105
Appendix D: Warranty, Product Registration and Support.....	110

Chapter 1: Introduction

Quick Start Guide

The following instructions will help you quickly install and configure your Smart POPS CDU for use in your data center equipment cabinet. For detailed information on each step, go to the page number listed to the right.

1. Mount the Smart POPS CDU7
2. Connect to the power source8
3. Connect the devices.....9
4. Connect the sensors9
5. Connect to the Smart POPS CDU9
6. Configure the Smart POPS CDU11
 - Login as the predefined Administrator (admin/admin)12
 - Configure the network settings21
 - Create new administrative user account25
 - Configure location and Smart POPS CDU names19
 - Configure sensor names.....21
 - Configure new user account(s)25
 - Remove the predefined Administrator29
7. Connect the Smart POPS CDU to the network.

Technical Support



Experience Server Technology's FREE SMARTER Technical Support

Server Technology understands that there are often questions when installing and/or using a new product. Free Technical Support is provided from 8 a.m. to 5 p.m. PST, Monday through Friday. After-hours service is provided to ensure your requests are handled quickly no matter what time zone or country you are located in.

Server Technology, Inc.

1040 Sandhill Drive

Tel: 775.284.2000

Web: www.servertech.com

Reno, Nevada 89521 USA

Fax: 775.284.2065

Email: support@servertech.com

Equipment Overview

1. The power inlet/cord(s) connects the CDU to the electrical power source.
2. The Input Current LED(s) displays the current load for each infeed or electrical phase per infeed.
3. Two RJ45 connectors for Serial (RS-232) and Ethernet connection
4. Two mini RJ11 connectors for Temperature/Humidity sensors.

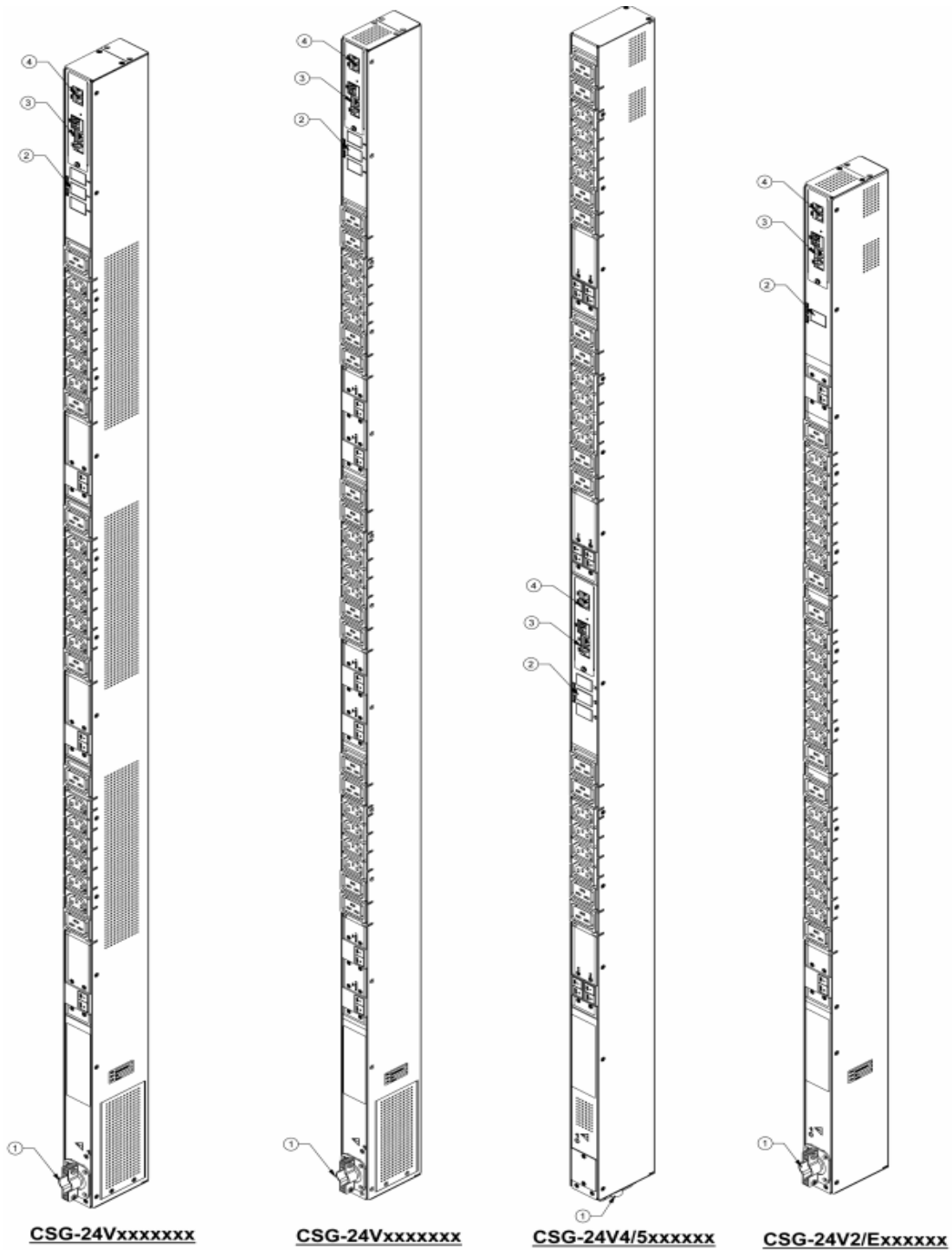

Figure 1.1 Smart POPS Cabinet Distribution Unit (CDU) – Product Family Views

Chapter 2: Installation

Before installing your Sentry Smart POPS Cabinet Distribution Unit (CDU), refer to the following lists to ensure that you have all the items shipped with the unit as well as all other items required for proper installation.

Standard Accessories

- Mounting hardware:
 - Vertical models -*
 - Two removable flanges with four M4 screws.
 - Two mounting L-brackets with nut plates, four sets of screws and washers.
 - Optional button mounts.
 - Horizontal models -*
 - Two removable L-brackets with M4 screws.
- Cables/Adapters:
 - RJ45 to RJ45 crossover cable.
 - RJ45 to DB9F serial port adapter (for connection to standard DB9M DTE serial port).
- Outlet retention clips (208-240V models).

Additional items for models with IEC 60320 C20 inlets:

- Separate power input cord.
- Power input retention bracket hardware (may be installed):
 - Two removable T-brackets with two 40mm screws per input.

Optional Accessories

- Temperature/Humidity sensors

Additional Required Items

- Flathead and Phillips screwdrivers
- Screws, washers and nuts to attach the CDU to your rack

Safety Precautions

This section contains important safety and regulatory information that should be reviewed before installing and using the Sentry Smart POPS Cabinet Distribution Unit. For input and output current ratings, see *Power Ratings* in Appendix C: Technical Specifications.

	Only for installation and use in a Service Access Location in accordance with the following installation and use instructions.	Destiné à l'installation et l'utilisation dans le cadre de Service Access Location selon les instructions d'installation et d'utilisation.	Nur für Installation und Gebrauch an Anschlusszugriffspunkten gemäß der folgenden Installations- und Gebrauchsanweisungen.
	This equipment is designed to be installed on a dedicated circuit.	Cet équipement est conçu à être installé sur un circuit spécialisé.	Diese Ausrüstung ist zur Installation in einem festen Stromkreis vorgesehen.
	Dedicated circuit must have circuit breaker or fuse protection. CDUs have been designed without a master circuit breaker or fuse to avoid becoming a single point of failure. It is the customer's responsibility to provide adequate protection for the dedicated power circuit. Protection of capacity equal to the current rating of the CDU must be provided and must meet all applicable codes and regulations. In North America, protection must have a 10,000A interrupt capacity.	Le circuit spécialisé doit avoir un disjoncteur ou une protection de fusible. CDUs ont été conçus sans disjoncteur général ni fusible pour éviter que cela devienne un seul endroit de panne. C'est la responsabilité du client de fournir une protection adéquate pour le circuit-alimentation spécialisé. Protection de capacité équivalant à la puissance de l'équipement, et respectant tous les codes et normes applicables. Les disjoncteurs ou fusibles destinés à l'installation en Amérique du Nord doivent avoir une capacité d'interruption de 10.000 A.	Der feste Stromkreis muss mit einem Schutzscharter oder einem Sicherungsschutz versehen sein. CDUs verfügt über keinen Hauptschutzschalter bzw. über keine Sicherung, damit kein einzelner Fehlerpunkt entstehen kann. Der Kunde ist dafür verantwortlich, den Stromkreis sachgemäß zu schützen. Der Kapazitätsschutz entspricht der aktuellen Stromstärke der Geräte und muss alle relevanten Codes und Bestimmungen erfüllen. Für Installation in Nordamerika müssen Ausschalter bzw. Sicherung über 10.000 A Unterbrechungskapazität verfügen.
	Models with unterminated power inputs: Input connector must be installed by qualified service personnel. Input connector rating must be greater than or equal to the total current rating of the CDU and must meet all applicable codes and regulations.	Modèles avec entrées d'alimentation non terminées: Le connecteur d'entrée doit être installé par un personnel qualifié. La consommation du connecteur d'entrée doit être supérieure ou égale à la consommation de courant totale de la centrale à tour et doit être conforme aux normes et à la réglementation en vigueur.	Modelle mit Eingangskabeln ohne Stecker: Der Eingangsstecker darf nur von qualifiziertem Wartungspersonal installiert werden. Der Nennstrom des Eingangssteckers muss mindestens der Gesamtstromstärke der CDU sowie allen geltenden Codes und Bestimmungen entsprechen.
	The plug on the power supply cord shall be installed near the equipment and shall be easily accessible.	La prise sur le cordon d'alimentation sera installée près de l'équipement et sera facilement disponible.	Der Stecker des Netzkabels muss in der Nähe der Ausrüstung installiert werden und leicht zugänglich sein.
	Installation Orientation: Cx-xxVx-x units are design to be installed in vertical orientation.	Installation Orientation: Les unités Cx-xxVx-x sont conçues pour être installées dans une orientation verticale.	Installationsausrichtung: Cx-xxVx-x Einheiten sind zur vertikalen Installation vorgesehen.
	Always disconnect the power supply cord before opening to avoid electrical shock.	Toujours déconnecter le cordon d'alimentation avant d'ouvrir pour éviter un choc électrique.	Vor dem Öffnen immer Netzleitung abziehen um elektrischen Schlag zu vermeiden.
	WARNING! High leakage current! Earth connection is essential before connecting supply!	ATTENTION ! Haut fuite très possible ! Une connection de masse est essentielle avant de connecter l'alimentation !	ACHTUNG! Hoher Ableitstrom! Ein Erdungsanschluss ist vor dem Einschalten der Stromzufuhr erforderlich!
	WARNING! Cx-xxE-x units Double Pole/Neutral Fusing	ATTENTION ! Les unités Cx-xxE-x Double Pôle/Fusible sur le Neutre	ACHTUNG! Cx-xxE-x Zweipolige bzw. Neutralleiter-Sicherung
	ATTENTION! Observe precautions for handling Electrostatic Sensitive Devices.	Attention ! Respecter les mesures de sécurité en manipulant des dispositifs sensibles aux décharges électrostatiques.	Achtung! Vorsichtshinweise zur Handhabung elektrostatisch empfindlicher Geräte beachten.

Installing the Power Input Retention Bracket

For units with a total maximum output <30A, it may be necessary to install the power input retention bracket prior to mounting the unit within the rack.

To install the power input retention bracket:

1. Remove the two screws attaching the IEC 60320 C20 inlet to the enclosure.
2. Assemble and attach the retention bracket to the enclosure as shown.

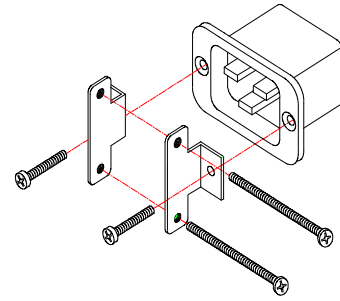

Figure 2.1 Retention Bracket Assembly

Mounting

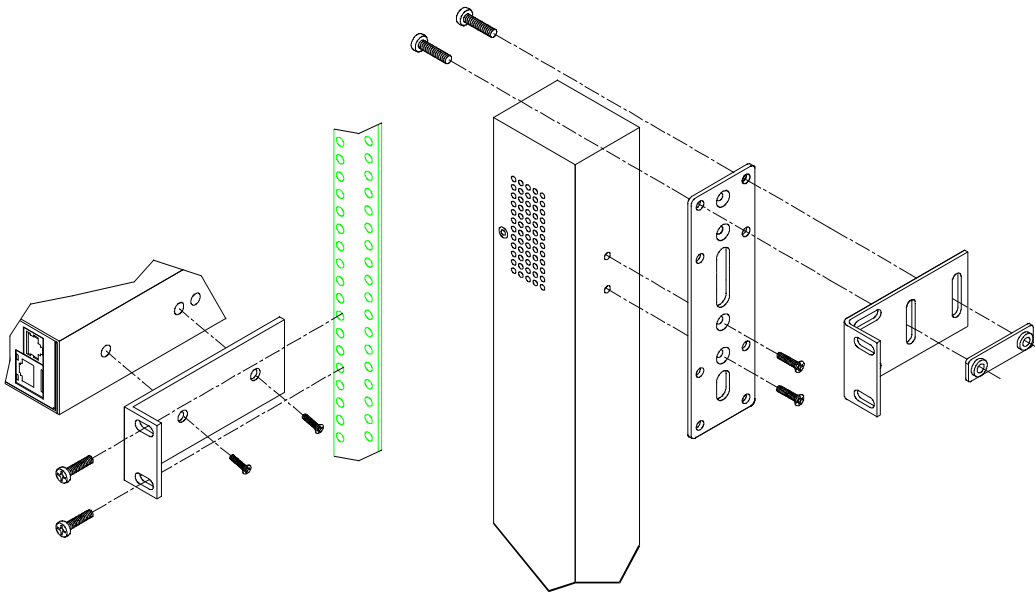

Figure 2.2 Mounting

Horizontal/Rack

1. Select the appropriate bracket mounting points for proper mounting depth within the rack.
2. Attach the L-brackets to these mounting points with two screws for each bracket.
3. Install the enclosure into your rack, using the slots in each bracket. The slots allow about ¼ inch of horizontal adaptability to align with the mounting holes of your rack.

NOTE: A mounting bracket kit for 23" wide racks or cabinets is available. Contact your Server Technology Sales Representative for more information.

Vertical

1. Attach the removable flanges to the mount points on the rear of the enclosure using M4 screws.
2. Attach the mounting L-brackets to the flanges with the supplied screws, washers and nut plates. The slots allow about 1½ inches of vertical adaptability.
3. Attach the top and bottom brackets to your rack.

NOTE: Contact your Server Technology Sales Representative for information regarding custom bracket design and fabrication services if you are unable to find a suitable manner for utilizing the included mounting brackets.

Optionally, the supplied button mounts may be used for mounting the CDU into cabinets supporting this method of equipment mounting.

Attaching the Expansion Module

If supported, connect the linking unit with the provided RJ12 crossover cable at the Link port on the Smart POPS CDU.

NOTE: The overall length of the RJ12 crossover cable should not exceed 14 feet (4.3 m).

Connecting to the Power Source

On 30A units, the input power cord is attached to the base of the unit. On units with a total maximum output <30A, you must first attach the power cord to the unit before connecting the unit to the power source.

To attach a power cord to the unit:

1. Plug the female end of the power cord firmly into its connector at the base.
2. Use a screwdriver to tighten the two screws on the retention bracket.

To connect to the power source:

Plug the male end of the power cord into the AC power source.

Connecting Devices

To avoid the possibility of noise due to arcing:

1. Keep the device's on/off switch in the off position until after it is plugged into the outlet.
2. Connect devices to the CDU outlets.

NOTE: Server Technology recommends even distribution of attached devices across all available outlets to avoid exceeding the outlet, branch or phase limitations. More information is provided in the Power Ratings section.



Always disconnect ALL power supply cords before opening to avoid electrical shock.
Afin d'éviter les chocs électriques, débranchez TOUTES les cables électrique avant d'ouvrir.
Vor dem Öffnen immer Netzleitungen abziehen um elektrischen Schlag zu vermeiden.

Connecting the Sensors

The Smart POPS CDU is equipped with two mini RJ11 T/H ports for attachment of the Temperature/Humidity sensors. Attach the mini RJ11 plug of the sensor(s) to the appropriate T/H port.

Connecting to the Unit

Serial (RS232) port

The Smart POPS Cabinet Distribution Unit is equipped with an RJ45 Serial RS-232 port for attachment to a PC or networked terminal server using the supplied RJ45 to RJ45 crossover cable and RJ45 to DB9F serial port adapter as required. See *Data Connections* in Appendix C: Technical Specifications for more information on the Serial RS-232 port.

Ethernet port

The Smart POPS Cabinet Distribution Unit is equipped with an RJ45 10/100Base-T Ethernet port for attachment to an existing network. This connection allows access to the Smart POPS CDU via Telnet or HTML.

The following network defaults are integrated with the Smart POPS CDU to allow unit configuration out-of-the-box through either Telnet or HTML:

- IP address: 192.168.1.254
- Subnet Mask: 255.255.255.0
- Gateway: 192.168.1.1

The local PC network connection must be configured as noted below:

NOTE: Contact your system administrator for instructions in reconfiguring the network connection. Reconfiguration of your network connection may require a restart to take effect.

- IP address: 192.168.1.x (where x is 2-253)
- Subnet Mask: 255.255.255.0

Chapter 3: Operations

INTERFACES	12
Usernames and Passwords	12
WEB INTERFACE	12
Logging In	13
System Summary	13
Power Monitoring	16
<i>Outlets</i>	16
<i>Input Feeds</i>	17
<i>System</i>	17
<i>UPS</i>	18
Environmental Monitoring	18
<i>Sensors</i>	18
<i>Contacts</i>	18
<i>ADCs</i>	19
Configuration	19
<i>System</i>	19
<i>Network</i>	21
<i>Telnet/SSH</i>	23
<i>HTTP/SSL</i>	24
<i>Serial Ports</i>	25
<i>Towers</i>	26
<i>Input Feeds</i>	27
<i>UPS</i>	27
<i>Users</i>	28
<i>FTP</i>	29
<i>SNTP/Syslog</i>	31
<i>SNMP/Thresholds</i>	32
<i>LDAP</i>	34
<i>TACACS+</i>	36
<i>RADIUS</i>	37
<i>Email</i>	38
<i>Features</i>	39
Tools	39
<i>Ping</i>	39
<i>Change Password</i>	40
<i>View Log</i>	40
<i>Restart</i>	41
COMMAND LINE INTERFACE	42
Logging In	42
Operations Commands	45
Administration Commands	47
<i>User Administration</i>	47
<i>Input Feed Administration</i>	49
<i>Tower Administration</i>	50
<i>Environmental Monitor Administration</i>	51
<i>Serial Port Administration</i>	52
<i>System Administration</i>	53
<i>TCP/IP Administration</i>	57
<i>HTTP Administration</i>	59
<i>Telnet Administration</i>	60
<i>FTP Administration</i>	60
<i>SNTP Administration</i>	62
<i>UPS Administration</i>	63

Interfaces

The Smart Cabinet Distribution Unit has two interfaces: the Web interface accessed via the HTTP enabled Ethernet connections, and the command line for serial and Telnet connections.

Username and Passwords

The Smart POPS Cabinet Distribution Unit has one predefined administrative user account (username/password: admn/admn), and supports a maximum of 112 defined user accounts.

NOTE: For security, Server Technology recommends removal of the predefined administrative user account after a new account with administrative rights has been created.

Only an administrative-level user may perform operations such as creating/removing user accounts and command privileges, changing passwords and displaying user information. An administrator may also view the status of all sensors and power inputs.

Usernames may contain from 1-16 characters and are not case sensitive; spaces are not allowed. Passwords may contain up to 16 characters, and are case sensitive.

Web Interface

The Web Interface provides web-based access to the Sentry Firmware. The interface is designed with three major sections, illustrated in the following screen example.

1. System Header: Shows the device description on the left (“Sentry Smart CDU” in this example); Shows the Sentry location, IP address of the unit, user login, and user access-level.
2. Navigation Bar: Provides access to CDU configuration, control action, or status page.
3. Details Window: Displays current control/status data based on the page selected from the navigation bar.

This example shows the **Power Monitoring > Input Feeds** page:

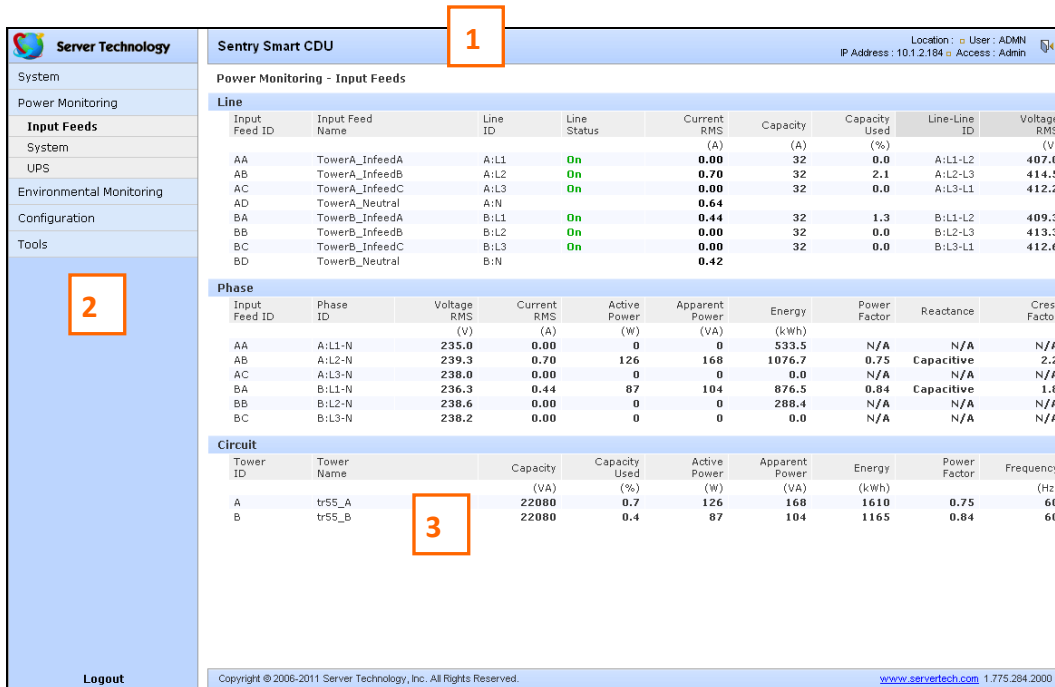

System		Power Monitoring - Input Feeds		Location: User: ADMN IP Address: 10.1.2.184 Access: Admin					
System		Line							
Input Feed ID	Input Feed Name	Line ID	Line Status	Current RMS (A)	Capacity (A)	Capacity Used (%)	Line-Line ID	Voltage RMS (V)	
AA	TowerA_InfeedA	A:L1	On	0.00	32	0.0	A:L1-L2	407.0	
AB	TowerA_InfeedB	A:L2	On	0.70	32	2.1	A:L2-L3	414.5	
AC	TowerA_InfeedC	A:L3	On	0.00	32	0.0	A:L3-L1	412.2	
AD	TowerA_Neutral	A:N		0.64					
BA	TowerB_InfeedA	B:L1	On	0.44	32	1.3	B:L1-L2	409.3	
BB	TowerB_InfeedB	B:L2	On	0.00	32	0.0	B:L2-L3	413.3	
BC	TowerB_InfeedC	B:L3	On	0.00	32	0.0	B:L3-L1	412.6	
BD	TowerB_Neutral	B:N		0.42					
System		Phase							
Input Feed ID	Phase ID	Voltage RMS (V)	Current RMS (A)	Active Power (W)	Apparent Power (VA)	Energy (kWh)	Power Factor	Reactance	Crest Factor
AA	A:L1-N	235.0	0.00	0	0	533.5	N/A	N/A	N/A
AB	A:L2-N	239.3	0.70	126	168	1076.7	0.75	Capacitive	2.2
AC	A:L3-N	238.0	0.00	0	0	0.0	N/A	N/A	N/A
BA	B:L1-N	236.3	0.44	87	104	876.5	0.84	Capacitive	1.8
BB	B:L2-N	238.6	0.00	0	0	288.4	N/A	N/A	N/A
BC	B:L3-N	238.2	0.00	0	0	0.0	N/A	N/A	N/A
System		Circuit							
Tower ID	Tower Name	Capacity (VA)	Capacity Used (%)	Active Power (W)	Apparent Power (VA)	Energy (kWh)	Power Factor	Frequency (Hz)	
A	tr55_A	22080	0.7	126	168	1610	0.75	60	
B	tr55_B	22080	0.4	87	104	1165	0.84	60	

Figure 3.1 Example of Firmware Web Interface for the Sentry Smart POPS CDU

Logging In

Logging in through HTML requires directing the HTML client to the configured IP address of the unit.

To log in by HTML:

In the login window, enter a valid username and password and press **OK**.

If you enter an invalid username or password, you will be prompted again.

You are given three attempts to enter a valid username and password combination. If all three fail, the session ends and a protected page will be displayed.

NOTE: The default Sentry username/password is `admn/admn`.

System Summary

The System Summary is typically displayed as the default page at user login to the Sentry firmware Web Interface. If you do not have environmental monitor access for a CDU, your default page at login will be the Outlet Control page (shown in Figure 3.1 above).

Both the System Summary page and the Outlet Control page display automatically at login and do not require enabling.

The System Summary page contains general system, line, humidity, and temperature status information. The color-coded sensor graphs shown in the example below provide a quick and efficient real-time view for monitoring environmental conditions in your CDU network.

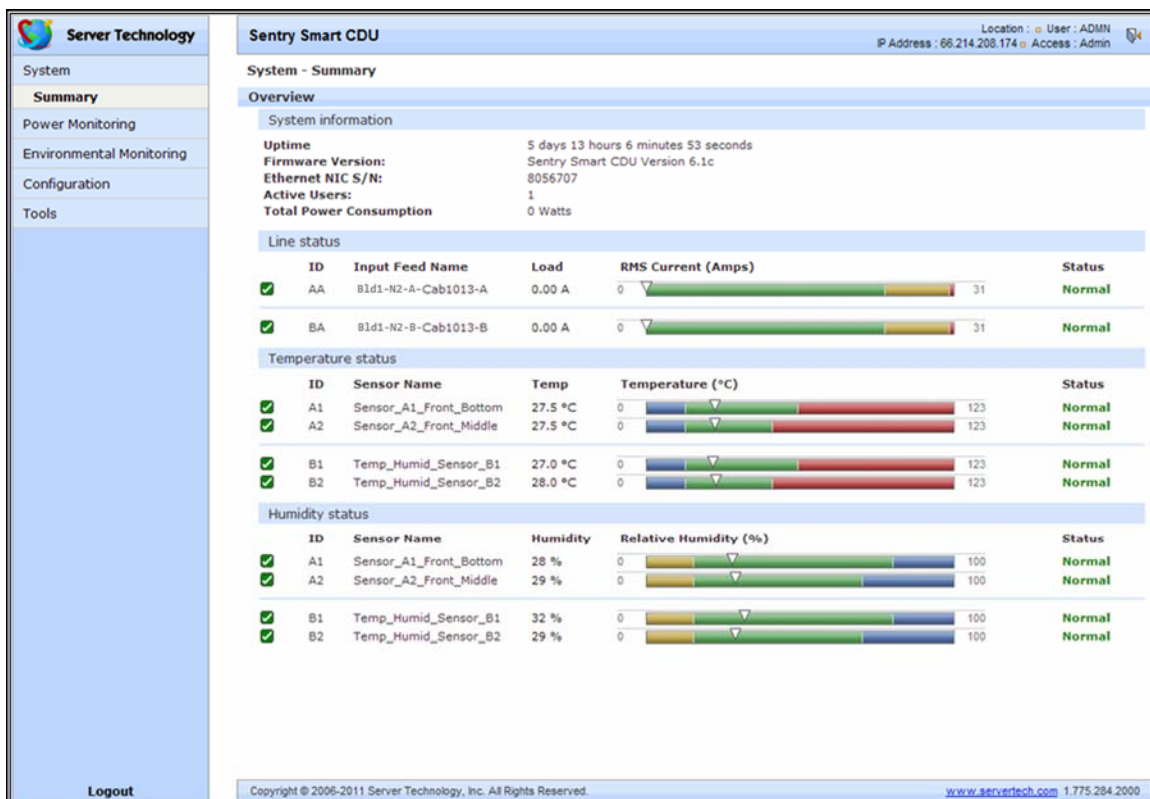

Figure 3.2 Example of System Summary Page

The System Summary page displays precise current and system power consumption in your CDU network. Dynamic updates (without a full page refresh) allow you to assess critical system statistics with close to instantaneous feedback. This performance is useful for monitoring new installation or power distribution changes in high-density computing environments. Power system administrators can also quickly identify thermal and humidity concerns that might otherwise escalate into costly infrastructure repairs if left unchecked.

As long as the System Summary page is active, the sensor graphs are continually updating system statistics and threshold values. The data with the most impact on the system is displayed to reduce your analysis and troubleshooting time. You can quickly analyze and correct a CDU if a sudden operating condition affects your device network.

NOTE: Because the System Summary page continually requests updated status information from the CDU, the page does not time-out. You will need to navigate to another page or manually log off.

System Information

Uptime: Displays the cumulative time the CDU has been up and running since the last unit restarted. Uptime shows continuous, real-time system updates with an approximate 5-second automatic refresh. A manual refresh of the System Summary page is not required.

Firmware Version: Shows the current Sentry firmware version.

Ethernet NIC S/N: Displays the CDU serial number derived from the Ethernet NIC.

Active Users: Displays the number of active user sessions accessing the Sentry firmware. These sessions include serial, TELNET, SSH, and Web sessions. Active Users also shows sessions that an unauthorized user may be attempting to access. The number shown in Active Users changes instantly as the number of active user sessions change.

NOTE: Depending on your web browser, multiple web accesses from the same machine are often treated as one user.

Total Power Consumption: Displays the total system power (in Watts) being distributed by the current Sentry CDU configuration.

Line Status

The Line Status graph displays a blinking warning (yellow), whenever the total input load on an infeed exceeds the present user set threshold. If an overload occurs, a blinking error condition (red) is displayed. The unit continues to display these yellow and red states until the condition changes or the problem has been resolved.

The default input feed high load threshold is 80% of the input feed maximum load capacity.

NOTE: The input feed high threshold is user-defined. You must configure this threshold value on the SNMP/Thresholds page or the Command Line Interface (CLI).

Temperature Status

The Temperature Status graph displays a blinking error whenever temperature exceeds the low or high threshold. The CDU will continue to display this state until the condition changes or the problem has been resolved.

For the temperature sensor, the default range of low/high temperature values is 5°-45° C (41°-115° F).

Up to four sets of dual temperature/humidity sensors can be displayed in this graph for a total of eight possible temperature sensor graphs. A thin blue line separates each set based on the tower or environmental monitor.

NOTE: The temperature threshold values are user-defined. You must configure these threshold values on the SNMP/Thresholds page or the Command Line Interface (CLI).

Humidity Status

The Humidity Status graph displays a blinking error whenever humidity exceeds the low or high threshold. The CDU will continue to display this state until the condition changes or the problem has been resolved.



For the humidity sensor, the default range of low/high humidity percentage is 0-100% (relative humidity).

Up to four sets of dual temperature/humidity sensors can be displayed in this graph for a total of eight possible humidity sensor graphs. A thin blue line separates each set based on the tower or environmental monitor.

NOTE: The humidity threshold values are user-defined. You must configure these threshold values on the SNMP/Thresholds page or the Command Line Interface (CLI).

Field Descriptions

The following fields and icons are viewed left to right for Line Status, Temperature Status, and Humidity Status:

Icon: Provides quick viewing of current operational state: Information , Warning , and Critical .

ID: Device input feed or sensor identifier.

Name: Descriptive, user-defined name for each input infeed or sensor.

Load, Temp, Humidity: Current state of the reported input load (in amps), current temperature, or current percentage of relative humidity.









Low Limit: Displays the user-defined low limit of the load, temperature, or humidity graph. These values depend on the sensor limited and cannot be set by the user. For example, a 0°C low limit would be displayed as  for a temperature sensor graph in Celsius.

Sensor Graph and Level Indicator: The horizontal sensor graph shows current operating conditions in color-coded segments. See the section below, “Sensor Graph Color-Coding”, for details. The level indicator  appears across the graph to indicate the relative position of the current data value with respect to the minimum (low limit) and maximum (high limit) values displayed at the left and right of the graph.

High Limit: Displays the high limit of the load, temperature, or humidity graph. These values depend on the sensor limits are cannot be set by the user. For example, a 100°C high limit would be displayed as  100 for a temperature sensor graph in Celsius.

Status: One of several operating conditions:

System Summary – Status Descriptions

Icon	Status	Description
	Reading	Unit is reading a new or restored sensor.
	Normal	Indicates normal operation.
	Load High	Infeed current load exceeds present High threshold.
	Over Load	Infeed current load exceeds the measurable range for the infeed.
	Temp Low	Current temperature falls below present Low threshold.
	Temp High	Current temperature exceeds present High threshold.
	Humid Low	Current percentage of relative humidity falls below present Low threshold.
	Humid High	Current percentage of relative humidity exceeds present High threshold.
	Lost	The connection was lost to a sensor that was previously detected and the sensor is pulled from the original environment monitoring statistics. There is no data to report, the graph is meaningless, and the threshold settings remain displayed but are grayed.

Sensor Graph Color-Coding

The following colors change dynamically on the sensor graphs to communicate operating conditions:

Line (Load) Status:

Green = Normal

Yellow = High load (load configured by user)

Red = Overload (based on device characteristics)

User configures load capacity at **Configuration > SNMP/Thresholds > Input Feed Traps and Thresholds**

Temperature Status:

Blue = cold; low temperature (threshold configured by user)

Green = acceptable temperature range

Red = hot; high temperature (threshold configured by user)

User configures low/high temperature thresholds at **Configuration > SNMP/Thresholds > Sensor Traps and Thresholds**

Humidity Status:

Blue = wet; high humidity (threshold configured by user)

Green = acceptable percentage of relative humidity

Yellow = dry; low humidity (threshold configured by user)

User configures low/high relative humidity thresholds at **Configuration > SNMP/Thresholds > Sensor Traps and Thresholds**

Logical Group Separators

Logical groups are separated by a thin blue line on the System Summary page as shown in the following example between Tower A_InfeedA and Tower B_InfeedA:

Line status					
ID	Input Feed Name	Load	RMS Current (Amps)		Status
✓ AA	TowerA_InfeedA	0.00 A	0		21 Normal
✓ BA	TowerB_InfeedA	0.25 A	0		21 Normal

This grouping includes master/link units in addition to some branched units. Up to three blue line dividers can be displayed on the System Summary page between all sensor groups.

Power Monitoring

NOTE: The following web interface examples show a Per Inlet Power Sensing (PIPS)-enabled Smart POPS CDU. PIPS provides power monitoring per infeed/inlet to the CDU to monitor (as data displayed in the following interface examples) current, voltage, power (W), apparent power, crest factor, reactance, power factor, and accumulated energy (kWh).

Outlets

The Outlets page displays:

- The absolute and descriptive names of the outlet
- Outlet status
- POPS outlet load in amperes.
- POPS outlet voltage
- POPS outlet active power in watts

Server Technology		Sentry Smart CDU				Location: User: ADMIN IP Address: 66.214.208.174 Access: Admin	
Power Monitoring - Outlets - Details							
Outlets							
Monitor outlets							
Outlet ID	Outlet Name	Outlet Status	Outlet Load (A)	Outlet Voltage (V)	Outlet Power (W)		
A1	Evernote-HPDL385	On	0.00	204.8	0	Details	
A2	TowerA_Outlet2	On	0.00	204.8	0	Details	
A3	TowerA_Outlet3	On	0.00	204.8	0	Details	
A4	TowerA_Outlet4	On	0.00	204.8	0	Details	
A5	TowerA_Outlet5	On	0.00	204.8	0	Details	
A6	TowerA_Outlet6	On	0.00	204.8	0	Details	
A7	TowerA_Outlet7	On	0.00	204.8	0	Details	
A8	TowerA_Outlet8	On	0.00	204.8	0	Details	
A9	TowerA_Outlet9	On	0.00	204.9	0	Details	
A10	TowerA_Outlet10	On	0.00	204.9	0	Details	
A11	TowerA_Outlet11	On	0.00	204.9	0	Details	
A12	TowerA_Outlet12	On	0.00	204.9	0	Details	
A13	TowerA_Outlet13	On	0.00	205.2	0	Details	
A14	TowerA_Outlet14	On	0.00	205.2	0	Details	
A15	TowerA_Outlet15	On	0.00	205.2	0	Details	
A16	TowerA_Outlet16	On	0.00	205.2	0	Details	
A17	TowerA_Outlet17	On	0.00	204.9	0	Details	
A18	TowerA_Outlet18	On	0.00	204.9	0	Details	
A19	TowerA_Outlet19	On	0.00	204.9	0	Details	
A20	TowerA_Outlet20	On	0.00	204.9	0	Details	

Sentry Smart CDU POPS (Per Outlet Power Sensing) combines all of the features and functions of a Smart CDU with the ability to provide power monitoring per an individual outlet/device.

For operational details about an outlet, click the Details link next to a specific outlet on the far right of the page.

The following outlet details page displays:

Power information per individual outlet/device includes current load (A), voltage (V), power (kW), apparent power (VA), crest factor, and power factor shown above on the Details page.

The Outlets page and Outlet Details page will refresh automatically every 10 seconds.

Input Feeds

The Input Feeds page displays:

- The absolute and descriptive names of the infeed
- Infeed status
- Input/branch phase load in amperes
- Input voltage
- Calculated power usage in Watts

Input Feed ID	Input Feed Name	Line ID	Line Status	Current RMS (A)	Capacity (A)	Capacity Used (%)	Line-Line ID	Voltage RMS (V)
AA	TowerA_InfeedA	A:L1	On	0.00	32	0.0	A:L1-L2	406.1
AB	TowerA_InfeedB	A:L2	On	0.70	32	2.1	A:L2-L3	413.9
AC	TowerA_InfeedC	A:L3	On	0.00	32	0.0	A:L3-L1	411.4
AD	TowerA_Neutral	A:N		0.64				
BA	TowerB_InfeedA	B:L1	On	0.44	32	1.3	B:L1-L2	408.4
BB	TowerB_InfeedB	B:L2	On	0.00	32	0.0	B:L2-L3	412.7
BC	TowerB_InfeedC	B:L3	On	0.00	32	0.0	B:L3-L1	411.8
BD	TowerB_Neutral	B:N		0.40				

Input Feed ID	Phase ID	Voltage RMS (V)	Current RMS (A)	Active Power (W)	Apparent Power (VA)	Energy (kWh)	Power Factor	Reactance	Crest Factor
AA	A:L1-N	234.5	0.00	0	0	533.5	N/A	N/A	N/A

This page will refresh automatically every 10 seconds.

System

The System page displays:

- Calculated power usage for all infeeds in Watts
- Configured total system area in square feet
- Calculated power usage in Watts/square foot

This page will refresh automatically every 10 seconds.

UPS

The UPS page displays the following information for each UPS device associated with the Sentry unit:

- Status
- Voltage
- Hostname/IP address

Server Technology		Sentry Smart CDU IP Address : 66.214.10.10			
System		Power Monitoring - UPS			
Power Monitoring		UPS Devices			
Outlets		Monitor UPS devices			
Input Feeds		Index	Type	Status	Voltage (V)
System		--	--	--	--
UPS					
Environmental Monitoring					
Configuration					
Tools					

This page will refresh automatically every 10 seconds.

Environmental Monitoring

Sensors

The Sensors page displays:

- The absolute and descriptive names of the temperature/humidity sensors
- Temperature/humidity sensor readings in degrees Celsius and percentage of relative humidity

Server Technology		Sentry Smart CDU IP Address : 66.214.10.10			
System		Environmental Monitoring - Sensors			
Power Monitoring		Temperature and Relative Humidity			
Environmental Monitoring		Monitor temperature and humidity sensor values			
Sensors		Sensor ID	Sensor Name	Temperature (°C)	Relative Humidity (%)
Contacts		A1	Sensor_A1_Front_Bottom	23.5	37
ADCs		A2	Sensor_A2_Front_Middle	23.0	38
Configuration		B1	Temp_Humid_Sensor_B1	22.5	40
Tools		B2	Temp_Humid_Sensor_B2	24.0	37
		Water			
		Monitor water sensor states			
		Sensor ID	Sensor Name	Sensor Status	
		B	Water_Sensor_B	Normal	

This page will refresh automatically every 10 seconds.

Contacts

The Contacts page displays:

- The absolute and descriptive names of the contact closure
- Contact closure status

Server Technology		Sentry Smart CDU		
System		Environmental Monitoring - Contacts		
Power Monitoring		Contact Closure		
Environmental Monitoring		Monitor contact closure states		
Sensors		Contact ID	Contact Name	Contact Status
Contacts		B1	Contact_Closure_B1	Normal
ADCs		B2	Contact_Closure_B2	Normal
Configuration		B3	Contact_Closure_B3	Normal
Tools		B4	Contact_Closure_B4	Normal

This page will refresh automatically every 10 seconds.

ADCs

The Analog-to-Digital Converters (ADCs) page displays:

- The absolute and descriptive names of the ADC
- The ADC count

ADC ID	ADC Name	ADC Count
B	ADC_B	18

This page will refresh automatically every 10 seconds.

Configuration

The Configuration section offers access to all unit configuration options. This section is available to administrative level users only.

System

The System configuration page is used for reference of system information such as Ethernet NIC Serial Number, Ethernet MAC address and system firmware and hardware revisions as well as assignment and maintenance of other system wide configurations.

System Information	Value
Firmware Version:	Sentry Smart CDU Version 6.1c
Ethernet NIC S/N:	8056707
Ethernet Address (MAC):	00-0a-9c-50-dd-83
Hardware Revision Code:	32 (ME)
Flash Memory Size:	2 MB
Uptime:	6 days 8 hours 17 minutes 19 seconds

Configure system options	Value
Location:	<input type="text"/>
Display Orientation:	Normal
Strong Passwords:	Disabled
Configuration Reset Button:	Enabled
Temperature Scale:	Celsius
Area (Footprint):	0.0 Square Meters
Power Factor:	1.00
CLI Session Timeout:	5 minutes
Web Session Timeout:	5 minutes

For descriptive names, enter up to 24 alphanumeric and other typed characters - (ASCII 33 to 126 decimal) are allowed; spaces are not allowed.

NOTE: Spaces may be used for the location description only.

Creating a pre-login banner:

Click the **Login Banner** link. On the subsequent Login Banner page, type pre-login banner text and press **Apply**.

NOTE: The pre-login banner can be up to 2069 characters in length and is displayed prior to the login prompt. If left blank, a system banner will not be displayed prior to the login prompt.

The Login Banner displays the following Characters Remaining box to show you in real-time as you type how many of the 2069 maximum characters are still available for you to complete your banner. The box adjusts dynamically as you type or delete characters.

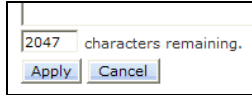

If you reach the maximum 2069 characters, the box displays “-1”. To clear your entry and start over, press **Cancel**.

Creating a descriptive system location name:

Enter a descriptive name and press **Apply**.

Configuring the Input Current LED display orientation:

Select **Normal** or **Inverted** from the drop-down menu and press **Apply**.

Enabling or disabling strong password requirements:

Sentry supports enforcement of strong passwords for enhanced security. When enabled, all new passwords must be a minimum of 8 characters in length with at least one uppercase letter, one lowercase letter, one number and one special character.

Acceptable strong passwords:

```
n0tOnmyw@tch  
john2STI?  
H3reUgo!
```

NOTE: Strong password requirements also enforce a minimum change of four character positions when defining new strong passwords.

Select **Enabled** or **Disabled** from the Strong Passwords drop-down menu and press **Apply**.

NOTE: The strong password requirement is applied against all new passwords.

Enabling or disabling the external reset button:

Select **Enabled** or **Disabled** from the External Reset Button drop-down menu and press **Apply**.

Setting the temperature scale:

Select **Celsius** or **Fahrenheit** from the Temperature Scale drop-down menu and press **Apply**.

Setting the system area:

Enter a system area value in the Area field and press **Apply**.

Setting the system area unit of measure:

Select the unit of measure from the Unit of Measure drop-down list and press **Apply**.

Setting the system input power factor:

The Power Factor value is used to provide calculated power usage displayed in the Power Monitoring pages.

Enter a numeric value in the Power Factor field from 0.50 to 1.00, and press **Apply**.

Setting the 3-phase load out-of-balance threshold:

This setting is used for devices with 3-phase input voltages to notify of a system imbalance between the three phases of power.

In the 3-Phase Load Out-of-Bounds Threshold field, enter a value from 0 to 100% and press **Apply**.

Configuring the Command Line Interface (CLI) session timeout:

Enter a timeout period (in minutes) in the CLI Session Timeout field, and press **Apply**. The valid timeout range is 1 to 1440 minutes (24 hours); the default is 5 minutes.

Configuring the web session (Web Interface) timeout:

Enter a timeout period (in minutes) in the Web Session Timeout field. The valid timeout range is 1 minute to 1440 minutes (24 hours); the default web session timeout is 5 minutes.

Creating a descriptive unit name:

Click on the **Tower Names** link.

On the subsequent Tower Names page, enter a descriptive name and press **Apply**.

Creating a descriptive input feed name:

Click on the **Input Feed Names** link.

On the subsequent Input Feed Names page, enter a descriptive name and press **Apply**.

Creating a descriptive serial port name:

Click the **Serial Port Names** link to open the Serial Ports configuration page. For more information about creating descriptive serial port names, see the Serial Ports section.

Creating a descriptive Environmental Monitor name:

Click on the **Environmental Monitor Names** link.

On the subsequent Environmental Monitor Names page, enter a descriptive name and press **Apply**.

Creating descriptive sensor names:

Click on the **Sensor Names** link.

On the subsequent Sensor Names page, enter a descriptive name and press **Apply**.

Creating analog-to-digital converter names:

Click on the **ADC Names** link.

On the subsequent ADC Names page, enter a descriptive name and press **Apply**.

Network

The Network configuration page is used for maintenance of the network interface. From this page an administrator may configure the IP address, subnet mask, gateway address, DNS addresses as well as view the link status, speed and duplex value.

Sentry Smart CDU	
Configuration - Network	
Network	
Network status	
Link:	Up
Speed:	100 Mbps
Duplex:	Full
Negotiation:	Auto
Configure network options	
DHCP:	Disabled
Boot Delay:	Enabled
Static Address Fallback:	Enabled
FQDN:	sentry3-50dd83
IP Address:	66.214.208.174
Subnet Mask:	255.255.255.0
Gateway:	66.214.208.1
DNS1:	71.9.127.107
DNS2:	68.190.192.35
<input type="button" value="Apply"/> <input type="button" value="Cancel"/>	

Enabling Dynamic Host Configuration Protocol (DHCP):

From the DHCP drop-down menu, select Enabled, and press **Apply**.

Enabling the DHCP boot delay:

NOTE: DHCP must be enabled to activate the DHCP Boot Delay option.

From the (DHCP) Boot Delay drop-down menu, select Enabled, and press **Apply**.

Enabling the Boot Delay option gives the CDU approximately 90-seconds to establish a connection through a DHCP server. This interval allows various network component activities to occur as the CDU powers up (such as obtaining SNTP time stamps for logging). This is the default state.

Disabling the Boot Delay option forces the CDU to boot after approximately 5-seconds regardless of the DHCP acquisition state. This speeds up a boot when a DHCP server is connected to one of the CDU's outlets. In this configuration, SNMP traps, SNTP, and other protocols will not be available until a DHCP address has been resolved.

NOTE: If the DHCP server boot time is excessive, you may want to disable the next option "DHCP Static Fallback Option".

Enabling the DHCP static address fallback:

NOTE: DHCP must be enabled to activate the DHCP Static Address Fallback option.

From the (DHCP) Status Address Fallback drop-down menu, select Enable, and press **Apply**.

Enabling the Static Address Fallback option informs the CDU to automatically fall back to a static address if a DHCP server does not respond after 90-seconds. This is the default state.

Disabling the Static Address Fallback option generates DHCP server requests until the CDU obtains a dynamic address.

NOTE: If the DHCP server boot time is excessive, you may need to disable the DHCP Static Address Fallback option.

Sentry network defaults

The Sentry is configured with the following network defaults to allow unit configuration out-of-the-box through either Telnet or HTML:

- IP address: 192.168.1.254
- Subnet Mask: 255.255.255.0
- Gateway: 192.168.1.1

The initial local PC network connection must be configured as noted below:

NOTE: Contact your system administrator for instructions in reconfiguring the network connection. Reconfiguration of your network connection may require a restart to take effect.

- IP address: 192.168.1.x (where x is 2-253)
- Subnet Mask: 255.255.255.0

NOTE: The unit must be restarted after network configuration changes. See Performing a warm boot:.

Setting the IP address, subnet mask, gateway or DNS address:

In the appropriate field, enter the IP address, subnet mask, gateway address or DNS address and press **Apply**.

Telnet/SSH

The Telnet/SSH configuration page used to enable or disable Telnet and SSH support and configure the port number that the Telnet or SSH server watches. For more information about SSH, see page 71.

The screenshot shows the configuration interface for Telnet and SSH on a Sentry Smart CDU. The interface is split into two main sections: Telnet and SSH. In the Telnet section, the 'Server' is set to 'Enabled' and the 'Port' is '23'. In the SSH section, the 'Server' is also 'Enabled', the 'Port' is '22', and both 'Password' and 'Keyboard-Interactive' authentication methods are checked. The left sidebar contains a navigation menu with various system settings categories.

Enabling or disabling Telnet or SSH support:

Select **Enabled** or **Disabled** from the appropriate Server drop-down menu and press **Apply**.

Changing the Telnet or SSH server port number:

In the appropriate Port field, enter the port number and press **Apply**.

Enabling or disabling SSH server authentication methods:

The Sentry SSH server supports two authentication methods for security and validation: Password and Keyboard-Interactive.

Password is a method where the SSH client gathers username/password credentials and makes the authentication request to the SSH server with the credentials. The Password method is controlled by the SSH client.

Keyboard-Interactive is an authentication method where the SSH server controls an information field followed by one or more prompts requesting credential information from the SSH client. The client gathers credential information keyed-in by the user and sends it back to the server. The Keyboard-Interactive method is controlled by the SSH server.

Individual enabling and disabling of the Password and Keyboard-Interactive authentication methods are supported to allow an SSH client to be forced to use a specific method. Although both methods are available, by enabling the Keyboard-Interactive method and disabling the Password method, the SSH client is forced to use Keyboard-Interactive, which is required to display the login banner.

NOTE: At least one authentication method must be enabled.

Select the **Password** checkbox and/or the **Keyboard-Interactive** checkbox and press **Apply**.

HTTP/SSL

The HTTP/SSL configuration page specifies settings that enable or disable HTTP and SSL support, configures the port number that the HTTP server watches and responds to, determines the SSL access level, and sets options for the Sentry Power Manager (SPM) product.

The screenshot shows the configuration interface for the Sentry Smart CDU. On the left is a navigation menu with categories like System, Power Monitoring, Environmental Monitoring, Configuration, Network, Telnet/SSH, HTTP/SSL (highlighted), Serial Ports, Towers, Input Feeds, UPS, Users, FTP, SNMP/Syslog, SNMP/Thresholds, LDAP, TACACS+, RADIUS, Email, Features, and Tools. The main content area is titled 'Sentry Smart CDU' and 'Configuration - HTTP/SSL'. It contains three sections: 'HTTP' with 'Server' set to 'Enabled' and 'Port' set to '80'; 'SSL' with 'Server' set to 'Enabled' and 'Secure Access' set to 'Optional'; and 'Sentry Power Manager' with 'SPM Secure Access' set to 'Enabled' and an unchecked 'SPM Password' checkbox. Each section includes 'Apply' and 'Cancel' buttons.

Enabling or disabling HTTP or SSL support:

Select **Enabled** or **Disabled** from the appropriate Server drop-down menu and press **Apply**.

NOTE: HTTPS must be used for secure website connections.

Changing the HTTP server port number:

In the HTTP Port field, enter the port number and press **Apply**.

Setting SSL access level:

Sentry SSL supports configuration of SSL connections as being either optional or required. The default access level is set to optional.

- Optional –Both non-secure (HTTP) and SSL encrypted connections (HTTPS) are allowed access.
- Required – ONLY SSL encrypted connections (HTTPS) are allowed access.

Select **Optional** or **Required** from the Secure Access drop-down menu and press **Apply**.

Setting the Sentry Power Manager (SPM) options:

The Sentry Power Manager (SPM) is Server Technology's enterprise management software product for the data center. The configuration options provided allow you to enable/disable SPM and reset the SPM password to its default.

NOTE: The SPM options only apply if you are currently using Server Technology's SPM software. In addition, the SPM options are only available on the HTTP/SSL web page. There are no equivalent SPM options on the Command Line Interface (CLI).

SPM Secure Access:

If your operation does not currently use SPM software, you can disable SPM Secure Access. However, if disabled, the CDU will not be able to use the SPM suite of secure network capabilities or the advanced remote configuration.

Select **Enabled** or **Disabled** from the SPM Secure Access drop-down menu and press **Apply**.

NOTE: Both HTTP and SSL must be enabled or the SPM Secure Access option will not be permitted. When SPM Secure Access is permitted, the default is **Enabled**.

SPM Password:

Each CDU has a default unique SPM password that is used to communicate between SPM and the CDU. When SPM discovers a CDU in the network, SPM changes this password into a different unique password for added security. The SPM then continues to manage or alter these passwords as required for system security.

If a CDU is relocated or swapped from the system after a password was generated, the SPM may not be able to reestablish a connection to the unit. The SPM Password checkbox allows you to reset this back to the CDU's internal default password so the SPM can re-discover the device and add it to the system. Once the unit has been acquired by SPM, no further action is necessary.

To reset the password, check SPM Password and press **Apply**.

NOTE: Do not reset the password if SPM communication has already been established.

Serial Ports

The Serial Ports configuration page is used for maintenance of the serial port.

Port ID	Port Name	DSR Check	Action
CONSOLE	CONSOLE	On	Edit

NOTE: Pass-Thru connections may only be initiated from the command line interface via a Telnet/SSH session.

Setting the data-rate for all serial ports:

Select the serial port data-rate from the drop-down menu and press **Apply**.

Setting the serial port timeout value:

Enter the timeout value (in minutes) in the Connection Timeout field and press **Apply**.

Creating a descriptive serial port name:

Click on the **Edit** link in the Action column next to the port to be configured.

On the subsequent Serial Port Edit page, enter a descriptive name. Up to 24 alphanumeric and other typed characters (ASCII 33 to 126 decimal) are allowed; spaces are not allowed. Press **Apply**.

Enabling or disabling serial port active signal checking:

Click on the **Edit** link in the Action column next to the port to be configured.

On the subsequent Serial Port Edit page, select **On** or **Off** from the DSR Check drop-down menu and press **Apply**.

Towers

The Towers configuration page is used for assignment and/or editing of:

- Descriptive names
- Serial and Model numbers
- Operation voltage types

Tower ID	Tower Name	Serial Number	Model Number	3-Phase	AC/DC
A	Master	ADEG0000001	CSG-24V2C415A1	No	AC
B	Expansion	ADEH0000005	CLG-24V2C415A1	No	AC

NOTE: If set at the factory, the serial number, model number and voltage type WILL NOT be user-editable.

Creating a descriptive tower name:

In the Tower Name field, enter a descriptive name and press **Apply**.

Setting the tower serial number:

In the Serial Number field, enter the serial number of the unit and press **Apply**.

Setting the tower model number:

In the Model Number field, enter the model number of the unit and press **Apply**.

Setting the operational AC or DC voltage type:

From the AC/DC drop-down menu, select **AC** or **DC**, and press **Apply**.

Setting the operational AC voltage type:

From the 3-Phase drop-down menu, select **yes** or **no**, and press **Apply**.

Input Feeds

The Input Feeds configuration page is used for assignment and/or editing of input feed descriptive names, operational voltage and maximum load capacity.

Server Technology		Sentry Smart CDU							
System		Location : User : ADMIN IP Address : 10.1.2.184 Access : Admin							
Power Monitoring		Power Monitoring - Input Feeds							
Input Feeds		Line							
Input Feed ID	Input Feed Name	Line ID	Line Status	Current RMS (A)	Capacity (A)	Capacity Used (%)	Line-Line ID	Voltage RMS (V)	
AA	TowerA_InfeedA	A:L1	On	0.00	32	0.0	A:L1-L2	406.1	
AB	TowerA_InfeedB	A:L2	On	0.70	32	2.1	A:L2-L3	413.9	
AC	TowerA_InfeedC	A:L3	On	0.00	32	0.0	A:L3-L1	411.4	
AD	TowerA_Neutral	A:N		0.64					
BA	TowerB_InfeedA	B:L1	On	0.44	32	1.3	B:L1-L2	408.4	
BB	TowerB_InfeedB	B:L2	On	0.00	32	0.0	B:L2-L3	412.7	
BC	TowerB_InfeedC	B:L3	On	0.00	32	0.0	B:L3-L1	411.8	
BD	TowerB_Neutral	B:N		0.40					
Phase									
Input Feed ID	Phase ID	Voltage RMS (V)	Current RMS (A)	Active Power (W)	Apparent Power (VA)	Energy (kWh)	Power Factor	Reactance	Crest Factor
AA	A:L1-N	234.5	0.00	0	0	533.5	N/A	N/A	N/A

Creating a descriptive input feed name:

In the Input Feed Name field, enter a descriptive name and press **Apply**.

Setting the infeed operational voltage:

In the Input Feed Voltage field, enter a value from 0 to 480 and press **Apply**.

NOTE: If Smart Load-Shedding has been activated and UPS voltage polling configured for an infeed, the polled voltage value will be used for all power calculations.

Setting the infeed maximum load capacity:

In the Input Feed Load Capacity field, enter a value from 1 to 255 and press **Apply**.

UPS

The UPS Configuration page is used for adding a new UPS device and configuring the UPS devices connected to Sentry units.

Server Technology		Sentry Smart CDU					
System		Location : User : ADMIN IP Address : 66.214.208.174 Access : Admin					
Power Monitoring		Configuration - UPS					
Environmental Monitoring		UPS Devices					
Configuration		Add a new UPS device					
System		Type:	Generic (RFC1628)				
Network		Hostname/IP:	<input type="text"/>				
Telnet/SSH		<input type="button" value="Apply"/>	<input type="button" value="Cancel"/>				
HTTP/SSL		Edit a UPS device					
Index	Type	Hostname/IP	Voltage Polling	SNMP Community String	SNMP Port	Action	
--	--	--	--	--	--	--	
Serial Ports							
Towers							
Input Feeds							
UPS							
Users							
FTP							
SNTP/Syslog							
SNMP/Thresholds							
LDAP							
TACACS+							
RADIUS							
Email							
Features							
Tools							

To add a new UPS:

Select the UPS manufacturer type from the Type drop-down list, type an IP address (or hostname) for the UPS, and press **Apply**.

To edit the UPS type:

Under the Action heading, click the **Edit** link for the UPS to be configured. The Configuration UPS page reformats to an edit page where UPS device settings are configured and UPS devices are associated with an infeed.

Selecting the UPS type:

Select the UPS manufacturer type from the UPS Type drop-down list and press **Apply**.

Editing the UPS Hostname/IP Address:

In the Hostname/IP field, type an IP Address or Hostname and press **Apply**.

Editing the UPS SNMP GET community string:

In the SNMP GET Community String field, type the community string configured on the UPS device and press **Apply**.

Enabling/Disabling UPS voltage polling:

From the Poll UPS Voltage drop-down list, select **Enabled** or **Disabled** and press **Apply**.

Editing the UPS SNMP port number:

In the Port field, type the port number and press **Apply**.

Associate the UPS with an infeed:

Select the infeed(s) powered by the UPS and press **Apply**.

To remove a UPS:

On the Configuration UPS page, under the Action heading, click the **Remove** link for the UPS you want to remove.

Users

The Users configuration page is used for creation and removal of usernames, assignment of privilege levels, and the changing of user passwords.

User Name	Access Level	Access Rights	Action
ADMN	Admin	ALL	Edit Remove
OverIPGroup	User	Ports	Edit Remove

Creating a new user:

Enter a user name in the Username field. Up to 16 alphanumeric and other typed characters (ASCII 33 to 126 decimal) are allowed; spaces are not allowed.

Enter a password for the new user and verify in the Password and Verify Password fields. For security, password characters are not displayed. Press **Apply**.

Removing a user:

Click on the **Remove** link in the Action column for the user to be removed and press **Yes** on the subsequent confirmation window.

Changing a user password:

Click on the **Edit** link in the Action column for the associated user.

On the subsequent User Edit page, enter a password and verify the new password for the new user in the Password and Verify Password fields. For security, password characters are not displayed. Press **Apply**.

Changing a user's access privilege level:

The Sentry user access levels are Admin, Power, and User:

- Admin: Full-access for all configuration and serial/Pass-Thru ports.
- Power: Same as Admin but without access to user configuration and control.
- User: Partial-access for serial/Pass-Thru ports.

The administrator can also grant administrative privileges to other user accounts, which allows the Sentry to have more than one administrative-level user.

NOTE: You cannot remove administrative privileges from the **admin** user unless another user has already been given administrative access level privileges created.

Click on the **Edit** link in the Action column for the associated user.

On the subsequent User Edit page, select **Admin** or **User** from the Access Level drop-down menu and press **Apply**.

Adding and Deleting serial port access:

Click on the **Ports** link in the Access column for the associated user.

On the subsequent User Ports page, select or deselect ports to be accessed by the user and press **Apply**.

FTP

The FTP configuration page is used for setup and maintenance of all settings required to perform an FTP firmware upload, configure automatic FTP updates or system configuration uploads/downloads. For more information about uploading firmware, see Appendix B: Uploading Firmware.

The screenshot shows the 'Sentry Smart CDU' configuration page for 'FTP'. The left sidebar lists various system settings, with 'FTP' selected. The main content area is titled 'Configuration - FTP' and contains three sections:

- Configure FTP client options:** Includes fields for Host (66.214.208.6), Username (anonymous), Password (masked), Directory (pub/firmware/Sentry3/Version_6/Smart), and Filename (smcdu-v61c.bin). There are 'Apply', 'Cancel', and 'Test' buttons.
- Configure FTP automatic update options:** Includes a dropdown for 'Automatic Updates' (set to Disabled), 'Scheduled Day' (Everyday), and 'Scheduled Hour' (12 AM). There are 'Apply' and 'Cancel' buttons.
- Configure FTP server options:** Includes a dropdown for 'FTP Server' (set to Enabled). There are 'Apply' and 'Cancel' buttons.

Setting the FTP Host Address:

Enter the IP address or hostname in the Host field and press **Apply**.

Setting the FTP username:

Enter the FTP server username in the Username field, and press **Apply**.

Setting the FTP password:

Enter the FTP server password in the Password field, and press **Apply**.

Setting the Directory (filepath):

Enter the path of the file to be uploaded in the Directory field, and press **Apply**.

Setting the filename for upload:

Enter the filename of the file to be uploaded in the Filename field, and press **Apply**.

Testing the FTP upload configuration:

This test validates that the unit is able to contact and log onto the specified FTP server, download the firmware file and verify that the firmware file is valid for this unit.

Press **Test**.

Enabling or disabling automatic updates:

The Sentry features the ability to schedule automatic firmware updates. When enabled and configured, the Sentry will regularly check the FTP server for a new firmware image and upload it.

Select **Enabled** or **Disabled** from the drop-down menu and press **Apply**.

Setting the automatic update scheduled day:

Select the desired day for the automatic update from the drop-down menu and press **Apply**.

Setting the automatic update scheduled hour:

Select the desired hour for the automatic update from the drop-down menu and press **Apply**.

Enabling or disabling the FTP server:

The Sentry features the ability to upload and download system configuration files to ease implementation across multiple Sentry devices. For more information about configuration upload and download, see Chapter 4: Advanced Operations – Upload/Download.

Select **Enabled** or **Disabled** from the drop-down menu and press **Apply**.

NOTE: The FTP server must be enabled for configuration upload or download.

SNTP/Syslog

The SNTP/Syslog configuration page allows setup and maintenance of SNTP and Syslog support. For additional Syslog information and configuration requirements, see Logging on page 97.

The screenshot shows the configuration interface for Sentry Smart CDU. On the left is a navigation menu with categories like System, Power Monitoring, Environmental Monitoring, Configuration, and Tools. The main area is titled 'Sentry Smart CDU' and 'Configuration - SNTP/Syslog'. It is divided into two sections: 'SNTP' and 'Syslog'. The 'SNTP' section includes 'SNTP information' with a date/time field set to '2011-09-14 18:29:35' and an 'Update' button. Below it is 'Configure SNTP server options' with fields for 'Primary Host' (2.us.pool.ntp.org), 'Secondary Host' (3.us.pool.ntp.org), and 'Local GMT Offset (Hours)' (a dropdown menu set to '+1'). There are 'Apply' and 'Cancel' buttons. The 'Syslog' section includes 'Configure Syslog server options' with fields for 'Primary Host', 'Secondary Host', and 'Port' (514), also with 'Apply' and 'Cancel' buttons.

Setting the SNTP server address:

Enter the IP address or hostname in the Primary and/or Secondary Host field and press **Apply**.

Setting the Local GMT offset:

Select the local offset from GMT value from the drop-down menu and press **Apply**.

Setting the Syslog server address:

Enter the IP address or hostname in the Primary and/or Secondary Host field and press **Apply**.

Changing the Syslog server port number:

In the Syslog Port field, enter the port number and press **Apply**.

SNMP/Thresholds

The SNMP/Thresholds configuration page allows setup and maintenance of all settings required to enable SNMP support and provides access to the trap configuration pages. For additional information on SNMP support and detailed descriptions of available traps, *SNMP* on page 73.

The screenshot shows the configuration interface for the Sentry Smart CDU. On the left is a navigation menu with categories like System, Power Monitoring, Environmental Monitoring, Configuration, Towers, and Tools. The main content area is titled 'Sentry Smart CDU' and 'Configuration - SNMP/Thresholds'. It is split into two sections: 'SNMP' and 'Traps and Thresholds'. The 'SNMP' section has a 'Configure SNMP agent options' header and several fields: 'SNMP Agent' (a dropdown menu set to 'Enabled'), 'GET Community' (text input 'public'), 'SET Community' (text input 'private'), 'TRAP Community' (text input 'trap'), 'Error Trap Repeat Time' (text input '60' followed by 'seconds'), 'Trap Destination 1' and 'Trap Destination 2' (empty text inputs), 'IP Restrictions' (a dropdown menu set to 'No Restrictions'), 'SysName' (text input 'Sentry3_50dd83'), 'SysLocation' (text input 'No Location'), and 'SysContact' (text input 'No Contact'). There are 'Apply' and 'Cancel' buttons. The 'Traps and Thresholds' section has a 'Configure SNMP traps and event thresholds' header and a list of links: 'Tower Traps', 'Input Feed Traps and Thresholds', 'Outlet Traps and Thresholds', 'Environmental Monitor Traps', 'Sensor Traps and Thresholds', 'Contact Closure Traps', and 'ADC Traps and Thresholds'.

NOTE: Traps are generated according to a hierarchical architecture; i.e. if a Tower Status enters a trap condition, only the Tower Status trap is generated. Infeed and Outlet Status traps are suppressed until the Tower Status returns to Normal.

Enabling or disabling SNMP support:

Select **Enabled** or **Disabled** from the drop-down menu and press **Apply**.

NOTE: The default for SNMP support is **Enabled**.

Setting the community strings:

Enter the community string in the appropriate field and press **Apply**.
Community strings may be 1 to 24 characters

Setting the trap timer:

Enter a trap timer value in the Error Trap Repeat Time field and press **Apply**.
The Error Trap Repeat Time value may be 1 to 65535 (in seconds).

Setting trap destinations:

Enter an IP address or hostname in the appropriate Trap Destination field and press **Apply**.

Setting IP Restrictions:

Select **No Restrictions** or **Trap Destinations Only** from the IP Restrictions drop-down menu and press **Apply**.

NOTE: When **Trap Destinations Only** is selected, SNMP Manager GET and SET requests are only allowed from the IP addresses of the defined traps destinations.

Setting the SNMP SysName, SysLocation or SysContact objects:

In the appropriate field, enter the SysName, SysLocation or SysContact objects and press **Apply**.

Enabling or disabling tower traps:

Click on the **Tower Traps** link.

On the subsequent Tower Traps page, select or deselect the desired traps and press **Apply**.

Configuring input feed traps:

Click on the **Input Feed Traps** link.

On the subsequent Input Feed Traps page, select or deselect the desired traps and press **Apply**.

For Load traps, enter a maximum load value for the infeed in the High Load Threshold field and press **Apply**. The default input feed high load threshold is 80% of the input feed maximum load capacity.

Configuring outlet traps:

Click on the **Outlet Traps and Thresholds** link.

On the subsequent page, select or deselect the desired traps and press **Apply**.

For the Low Load traps, enter a minimum load value (in whole amps) and press **Apply**. The default Low Load threshold is 0 A.

For the High Load traps, enter a maximum load value and press **Apply**. The default threshold is 80% of the maximum outlet load capacity.

Enabling or disabling Environmental Monitor traps:

Click on the **Environmental Monitor Traps** link.

On the subsequent page, select or deselect the desired traps and press **Apply**.

Configuring the Temperature and Relative Humidity sensor traps:

Click on the **Sensor Traps and Thresholds** link.

On the subsequent Sensor Traps and Thresholds page, select or deselect the desired trap checkboxes and press **Apply**.

Configuring the Temperature and Relative Humidity sensor thresholds:

Click the **Sensor Traps and Thresholds** link.

For temperature thresholds, type a low and high temperature value in the Low Temp and High temp fields and press **Apply**.

For relative humidity thresholds, type a low and high humidity percentage in the Low Humid and High Humid fields, and press **Apply**.

NOTE: For temperature **thresholds**, the valid range is 0 to 123 degrees Celsius or 32 to 254 degrees Fahrenheit. For **relative humidity**, the valid range is 0 to 100 (in percent relative humidity).

Configuring Temperature Recovery Delta:

Click on the **Sensor Traps and Thresholds** link.

The Recovery Delta field allows configuration of the number of degrees of change needed to recover from a temperature alarm. After exceeding the high-temperature threshold, the temperature value must fall below the high-temperature threshold by the number of degrees specified in the Recovery Delta field before the sensor recovers.

For example, if the High Temp value is 80 degrees Fahrenheit, and the Recovery Delta field is 2 degrees Fahrenheit, the sensor will not recover until a temperature value of 78 degrees Fahrenheit is reported.

To configure a temperature recovery delta, type a value (in degrees) in the Recovery Delta field and press **Apply**.

NOTE: The acceptable value range for the Recovery Delta field is 0-10 degrees for Celsius and 0-18 degrees for Fahrenheit. The default value for the Recovery Delta field is 1 degree Celsius and 2 degrees Fahrenheit.

LDAP

The LDAP configuration page is used for setup and maintenance of all settings required to enable LDAP support. For additional LDAP information and configuration requirements, see *LDAP* on page 81.

The screenshot shows the LDAP configuration interface for Sentry Smart CDU. The left sidebar lists various system settings, with 'LDAP' highlighted. The main panel is titled 'Sentry Smart CDU Configuration - LDAP' and contains a 'Configure LDAP options' section. The 'LDAP' status is currently set to 'Disabled'. Other configuration options include 'Primary Host', 'Secondary Host', 'Port' (389), 'Use TLS/SSL' (No), 'Bind Type' (Simple), 'Search Bind DN', 'Search Bind Password' (with a 'Change' checkbox), 'User Search Base DN', 'User Search Filter', 'Group Membership Attribute', 'Group Membership Value Type' (DN), and 'Authentication Order' (Remote->Local). There are 'Apply' and 'Cancel' buttons at the bottom of the configuration section.

Enabling or disabling LDAP support:

Select **Enabled** or **Disabled** from the LDAP drop-down menu and press **Apply**.

Setting the LDAP server address:

Enter the IP address or hostname in the Primary and/or Secondary Host field and press **Apply**.

Changing the LDAP server port:

Enter the port number in the LDAP Port field and press **Apply**.

Enabling or disabling LDAP over TLS/SSL:

Select **Yes** or **No** from the Use TLS/SSL drop-down menu and press **Apply**.

NOTE: If LDAP over TLS/SSL is enabled, MD5 binding is disabled.

Setting the LDAP bind password type:

Select **Simple** or **MD5** from the Bind Type drop-down menu and press **Apply**.

NOTE: If MD5 binding is enabled, LDAP over TLS/SSL is disabled.

For more information about LDAP bind password types, see *Setting the LDAP bind password type* on page 83.

Setting the search bind Distinguished Name (DN):

Enter the fully-qualified distinguished name (FQDN) in the Search Bind field and press **Apply**.

Setting the search bind password for Distinguished Name (DN):

Enter the Search Bind Password in the Search Bind Password field and press **Apply**.

Setting the user search base Distinguished Name (DN):

Enter the User Search Base DN in the User Search Base DN field and press **Apply**.

Setting the user search filter:

Enter the User Search Filter in the User Search Filter field and press **Apply**.

Setting the group membership attribute:

Enter the group membership attribute in the Group Membership Attribute Field and press **Apply**.

Setting the group membership value type:

Select the appropriate value from the drop-down menu and press **Apply**.

Configuring the authentication order:

Select **Remote** -> **Local** or **Remote Only** from the drop-down menu and press **Apply**.

For more information about remote authentication order, see *Setting the authentication order* on page 85.

NOTE: Server Technology recommends NOT setting the authentication order to Remote Only until TACACS has been fully configured and tested.

Configuring LDAP groups:

Click on the **LDAP Groups** link at the bottom of the page.

Creating an LDAP group:

Enter a descriptive group name in the LDAP Group Name field. Up to 24 alphanumeric and other typed characters (ASCII 33 to 126 decimal) are allowed; spaces are not allowed. Press **Apply**.

Removing an LDAP group:

Click on the **Remove** link in the Action column for the group to be removed and press **OK** on the subsequent confirmation window.

Changing an LDAP group's access level:

Click on the **Edit** link in the Action column for the associated LDAP Group.

On the subsequent LDAP Group - Edit page, select **Admin**, **User**, **On-only** or **View-only** from the Access Level drop-down menu and press **Apply**.

Granting or removing Environmental Monitoring viewing privileges :

Click on the **Edit** link in the Action column for the associated LDAP Group.

On the subsequent LDAP Group - Edit page, select **Yes** or **No** from the Environmental Monitoring drop-down menu and press **Apply**.

Adding and Deleting serial port access:

Click on the **Ports** link in the Access column for the associated LDAP Group.

On the subsequent LDAP Group - Ports page, select or deselect ports to be accessed by the LDAP Group and press **Apply**.

TACACS+

The TACACS+ configuration page is used for setup and maintenance of all settings required to enable TACACS+ support. For additional TACACS+ information and configuration requirements, see *TACACS+* on page 89.

Enabling or disabling TACACS+ support:

Select **Enabled** or **Disabled** from the TACACS+ drop-down menu and press **Apply**.

Setting the TACACS+ server address:

Enter the IP address or hostname in the Primary and/or Secondary Host field and press **Apply**.

Changing the TACACS+ server port:

Enter the port number in the Port field and press **Apply**.

Configuring the authentication order:

Select **Remote -> Local** or **Remote Only** from the drop-down menu and press **Apply**.

For more information about remote authentication order, see *Setting the authentication order:* on page 90.

NOTE: Server Technology recommends **NOT** setting the authentication order to Remote Only until the LDAP has been fully configured and tested.

Setting the TACACS+ encryption key:

Enter a new key and verify it with the Encryption Key and Verify Encryption Key fields. Press **Apply**.

For security, key characters are not displayed.

Configuring TACACS+ privilege levels:

Click on the **TACACS+ Privilege Levels** link at the bottom of the page.

Changing a TACACS+ Privilege Level's access privilege level:

Click on the **Edit** link in the Action column for the associated TACACS+ Privilege Level.

On the subsequent TACACS+ Privilege Level - Edit page, select **Admin**, **User**, **On-only** or **View-only** from the Access Level drop-down menu and press **Apply**.

Adding and Deleting serial port access:

Click on the **Ports** link in the Access column for the associated TACACS+ Privilege Level.

RADIUS

The Remote Authentication Dial-in User Service (RADIUS) configuration page is used for setup and maintenance of all settings required to enable RADIUS support. For RADIUS configuration requirements, see *RADIUS* on page 93.

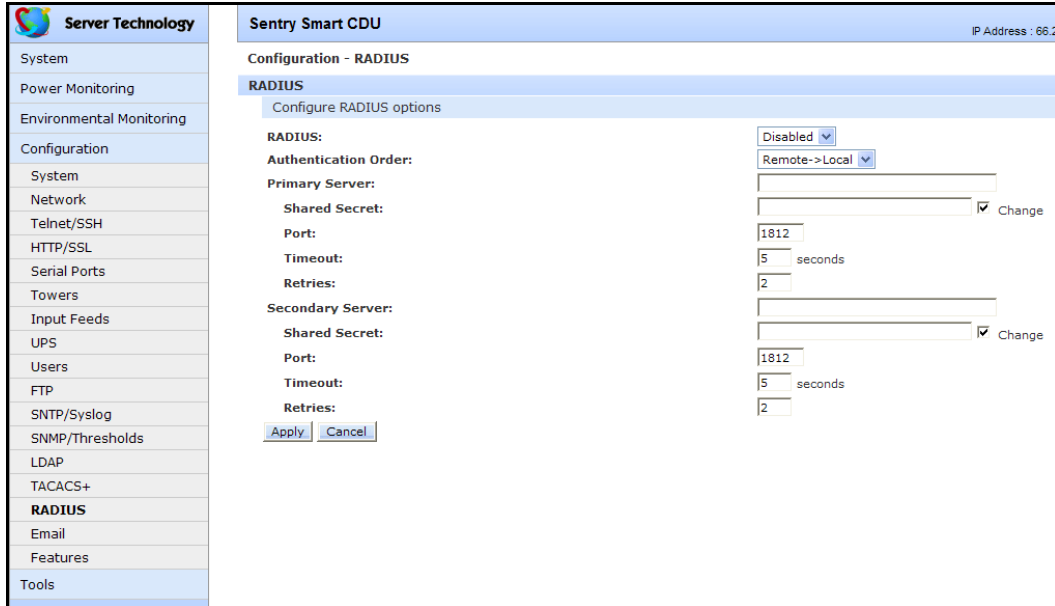

Enabling or disabling RADIUS support:

Select Enabled or Disabled from the RADIUS drop-down menu and press **Apply**.

Configuring the authentication order:

Select **Remote->Local** or **Remote Only** from the drop-down menu and press **Apply**.

For more information about remote authentication order, see *Setting the authentication order* on page 93.

NOTE: Server Technology recommends NOT setting the authentication order to Remote Only until the RADIUS has been fully configured and tested.

Changing the RADIUS server address:

Enter the IP address or hostname in the Primary and/or Secondary Server field and press **Apply**.

Setting the RADIUS shared secret:

The shared secret is the RADIUS authentication key.

Enter the shared secret in the Primary and Secondary Shared Secret field. Up to 48 upper and lowercase alphanumeric and other typed characters (ASCII 33 to 126 decimal) and spaces are allowed; control characters are not allowed.

Press **Apply**.

To change the shared secret, check the Change checkbox to clear the Shared Secret field, enter the new shared secret, and press **Apply**.

Changing the RADIUS server port:

This field specifies the port number used by the RADIUS server for incoming RADIUS authentication requests.

Enter the port number in the Primary and/or Secondary Port field and press **Apply**.

The valid port number range is 1-65535; default is 1812.

Setting the RADIUS server timeout value:

The Timeout field specifies the time interval (in seconds) to wait for a reply from the RADIUS server before resending an authentication request.

Enter the timeout value (in seconds) in the Primary and/or Secondary Timeout field and press **Apply**.

The valid timeout range is 1-30 seconds; default is 5 seconds.

Setting the number of RADIUS server retries:

The Set RADIUS Retries command specifies the number of times an authentication request is sent to the RADIUS server. The Sentry will attempt authentication with the primary server until the number of retries is reached, then will attempt authentication with the secondary server. If the Sentry does not receive a response from these attempts, the authentication request will be rejected.

Enter the number of retries in the Primary and/or Secondary Retries field and press **Apply**.

The valid retries range is 0-10; default is 2.

Email

The Email configuration page is used for setup and maintenance Email log support. For additional Email information and configuration requirements, see Email on page 98.

The screenshot shows the 'Sentry Smart CDU' configuration interface. On the left is a sidebar with a tree view containing categories like System, Power Monitoring, Environmental Monitoring, Configuration, Network, Telnet/SSH, HTTP/SSL, Serial Ports, Towers, Input Feeds, UPS, Users, FTP, SNMP/Syslog, SNMP/Thresholds, LDAP, TACACS+, RADIUS, Email, Features, and Tools. The main panel is titled 'Sentry Smart CDU' and 'Configuration - Email'. Under the 'Email' section, there is a 'Configure Email options' area. It includes a dropdown for 'Email Notifications' set to 'Disabled', a text field for 'SMTP Host', a text field for 'SMTP Port' with '25' entered, a text field for 'From' Address with 'Sentry3_50dd83@' entered, and empty text fields for 'Primary Send To' and 'Secondary Send To' addresses. Below these are three checkboxes: 'Include Event Messages' (checked/Enabled), 'Include Authentication Messages' (unchecked/Disabled), and 'Include Configuration Messages' (unchecked/Disabled). At the bottom of the configuration area are 'Apply' and 'Cancel' buttons.

Enabling or disabling Email support:

Select **Enabled** or **Disabled** from the Email Notifications drop-down menu and press **Apply**.

Setting the SMTP server address:

Enter the IP address or hostname in the SMTP Host field and press **Apply**.

Changing the SMTP server port:

Enter the port number in the SMTP Port field and press **Apply**.

Setting the 'From' email address:

Enter the 'from' email address in the 'From' Address field and press **Apply**.

Setting the 'To' email address:

Enter the 'to' email address in the Primary or Secondary 'Send To' Address field and press **Apply**.

Enabling or disabling event type notifications:

Select **Enabled** or **Disabled** from the Include...Messages drop-down menus and press **Apply**.

Features

The Features configuration page displays the product serial number and the active features currently in the system. The Features page also provides the Feature Key Value field where the administrator enters the license key value provided by Server Technology to activate a new system feature.

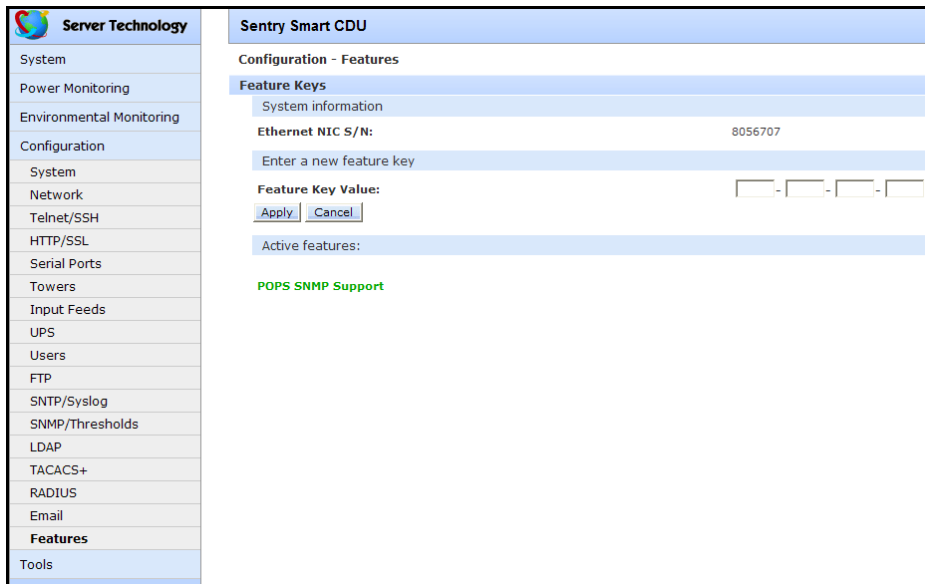

The screenshot shows the 'Sentry Smart CDU' configuration interface. On the left is a navigation menu with categories: System Technology, System, Power Monitoring, Environmental Monitoring, Configuration, Network, Telnet/SSH, HTTP/SSL, Serial Ports, Towers, Input Feeds, UPS, Users, FTP, SNMP/Syslog, SNMP/Thresholds, LDAP, TACACS+, RADIUS, Email, Features, and Tools. The main content area is titled 'Sentry Smart CDU' and 'Configuration - Features'. It includes a 'Feature Keys' section with 'System information' showing 'Ethernet NIC S/N: 8056707'. Below this is a form to 'Enter a new feature key' with a 'Feature Key Value' field containing four empty boxes separated by dashes, and 'Apply' and 'Cancel' buttons. The 'Active features:' section lists 'POPS SNMP Support'.

Tools

The Tools section contains access to rebooting the unit, uploading new firmware as well as resetting the unit to factory defaults. This section is available to administrative level users only.

Ping

The Ping feature may be used to test the Sentry's ability to contact another Ethernet enabled device's IP address. For LDAP support, it may also be used to test the configuration of the Domain Name System (DNS) server IP address by testing for proper name resolution.

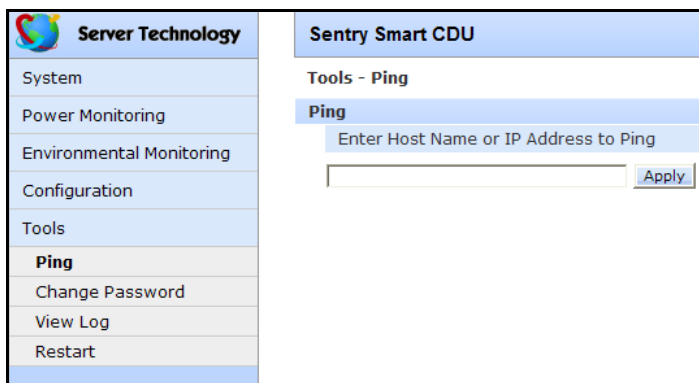

The screenshot shows the 'Sentry Smart CDU' configuration interface for the 'Tools - Ping' section. The left navigation menu is the same as in the previous screenshot, but the 'Features' category is expanded to show 'Ping', 'Change Password', 'View Log', and 'Restart'. The main content area is titled 'Sentry Smart CDU' and 'Tools - Ping'. It includes a 'Ping' section with the instruction 'Enter Host Name or IP Address to Ping' and a text input field followed by an 'Apply' button.

Change Password

The Change Password feature allows users to change their own password.

NOTE: An administrator can always assign a new password to a user.

Changing a password:

Enter the current password, enter a new password and verify the new password. Press **Apply**.

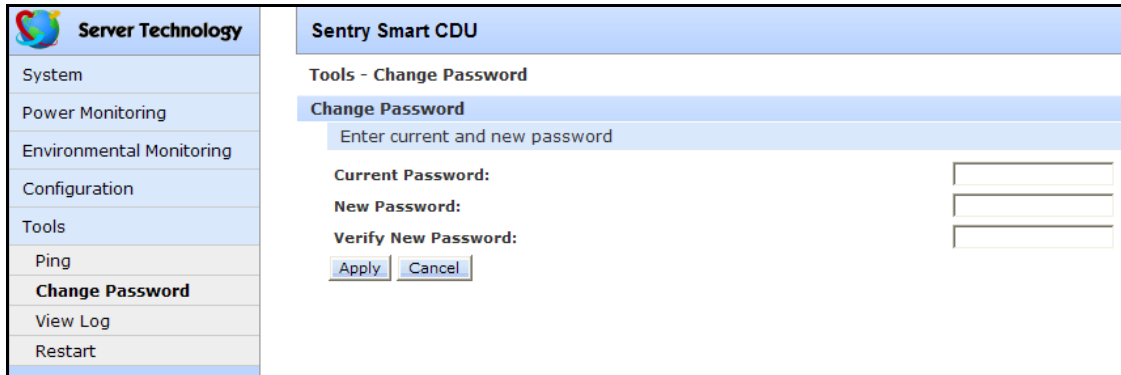

The screenshot shows the 'Sentry Smart CDU' interface with the 'Tools - Change Password' section active. The left sidebar contains a navigation menu with 'Change Password' selected. The main content area has a heading 'Change Password' and a sub-heading 'Enter current and new password'. Below this are three input fields labeled 'Current Password:', 'New Password:', and 'Verify New Password:'. At the bottom of the form are 'Apply' and 'Cancel' buttons.

View Log

The View Log feature enables viewing of the internal system log. This features logs all authentication attempts, power actions, configuration changes and other system events. The system memory stores more than 4000 entries in a continuously aging log. For permanent off-system log storage, the Syslog protocol is supported. For additional Syslog information and configuration requirements, see Syslog on page 97.

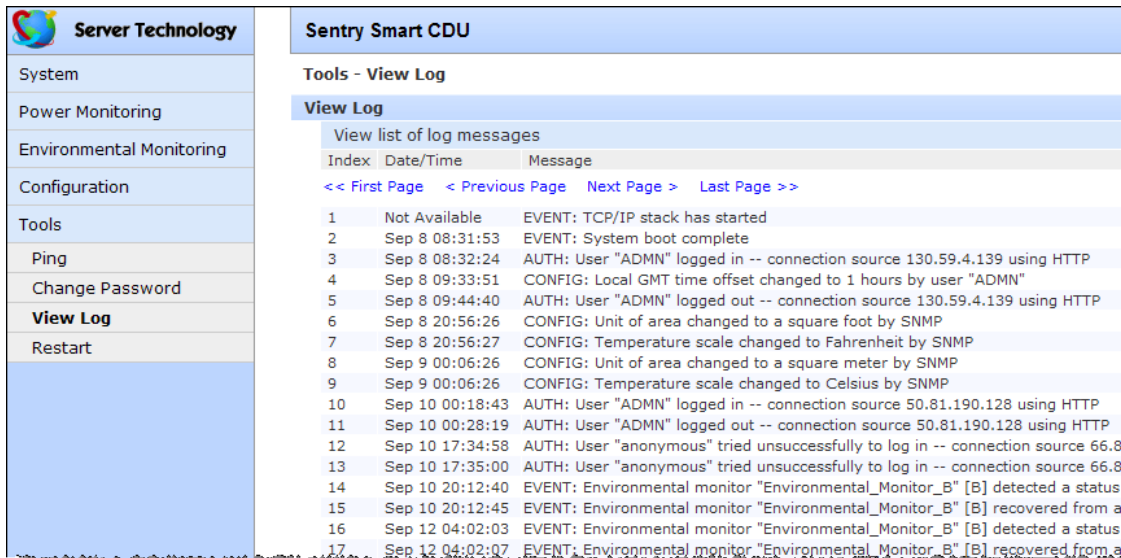

The screenshot shows the 'Sentry Smart CDU' interface with the 'Tools - View Log' section active. The left sidebar contains a navigation menu with 'View Log' selected. The main content area has a heading 'View Log' and a sub-heading 'View list of log messages'. Below this is a table with columns 'Index', 'Date/Time', and 'Message'. The table contains 17 rows of log entries. At the bottom of the table are navigation links: '<< First Page', '< Previous Page', 'Next Page >', and 'Last Page >>'.

Index	Date/Time	Message
1	Not Available	EVENT: TCP/IP stack has started
2	Sep 8 08:31:53	EVENT: System boot complete
3	Sep 8 08:32:24	AUTH: User "ADMN" logged in -- connection source 130.59.4.139 using HTTP
4	Sep 8 09:33:51	CONFIG: Local GMT time offset changed to 1 hours by user "ADMN"
5	Sep 8 09:44:40	AUTH: User "ADMN" logged out -- connection source 130.59.4.139 using HTTP
6	Sep 8 20:56:26	CONFIG: Unit of area changed to a square foot by SNMP
7	Sep 8 20:56:27	CONFIG: Temperature scale changed to Fahrenheit by SNMP
8	Sep 9 00:06:26	CONFIG: Unit of area changed to a square meter by SNMP
9	Sep 9 00:06:26	CONFIG: Temperature scale changed to Celsius by SNMP
10	Sep 10 00:18:43	AUTH: User "ADMN" logged in -- connection source 50.81.190.128 using HTTP
11	Sep 10 00:28:19	AUTH: User "ADMN" logged out -- connection source 50.81.190.128 using HTTP
12	Sep 10 17:34:58	AUTH: User "anonymous" tried unsuccessfully to log in -- connection source 66.84.13.10
13	Sep 10 17:35:00	AUTH: User "anonymous" tried unsuccessfully to log in -- connection source 66.84.13.10
14	Sep 10 20:12:40	EVENT: Environmental monitor "Environmental_Monitor_B" [B] detected a status e
15	Sep 10 20:12:45	EVENT: Environmental monitor "Environmental_Monitor_B" [B] recovered from a s
16	Sep 12 04:02:03	EVENT: Environmental monitor "Environmental_Monitor_B" [B] detected a status e
17	Sep 12 04:02:07	EVENT: Environmental monitor "Environmental_Monitor_B" [B] recovered from a s

NOTE: The system log is viewable only by users with administrative privileges.

Reviewing the system log:

Click on the **Previous 100 entries** or **Next 100 entries** link to navigate through the log.

Restart

Performing a warm boot:

Select the **Restart** from the Action drop-down menu and press **Apply**.



Note: System user/outlet/group configuration or outlet states are NOT changed or reset with this command.

Resetting to factory defaults:

For more information about resetting a Sentry to factory defaults from the Web interface, see Appendix A: Resetting to Factory Defaults on page 103.

Uploading new firmware:

For more information on uploading new firmware from the Web interface, see Appendix B: Uploading Firmware on page 104.

Generating a new SSL X.509 certificate:

Select the **Restart and generate a new X.509 certificate** from the Action drop-down menu and press **Apply**.

Computing new SSH security keys:

Select the **Restart and compute new SSH keys** from the Action drop-down menu and press **Apply**.

Command Line Interface

Logging In

Logging in through Telnet requires directing the Telnet client to the configured IP address of the unit.

Logging in through the Console (RS232) port requires the use of a terminal or terminal emulation software configured to support ANSI or VT100 and a supported data rate (300, 1200, 2400, 4800, 9600, 19200, 38400, 57600, or 115200 BPS) - 8 data bits-no parity-one stop bit and Device Ready output signal (DTR or DSR).

To log in by RS-232 or Telnet:

1. Press **Enter**. The following appears, where **x.xx** is the firmware version:
Sentry Version x.xx
Username:

NOTE: Logging in by Telnet will automatically open a session. It is not necessary to press Enter.

2. At the Username: and Password: prompts, enter a valid username and password. And press **Enter**.
You are given three attempts to enter a valid username and password combination. If all three fail, the session ends.

NOTE: The default Sentry username/password is admn/admn.

When you enter a valid username and password, the command prompt (Smart CDU:) appears. If a location identifier was defined, it will be displayed before the Smart POPS CDU: prompt.

You can enter commands in any combination of uppercase and lowercase characters. All command characters must be entered correctly; there are no command abbreviations. A user must have administrative privileges to use the administration commands. The following tables list and briefly describe each command.

Operations Command Summary

Command	Description
Connect	Connects to a serial/Pass-Thru port
Envmon	Displays the status of the integrated Environmental Monitor
IStat	Displays the status of the infeeds
List Ports	Lists all accessible serial/Pass-Thru ports for the current user
Login	Ends the current session and brings up the Username: prompt
Logout	Ends a session
Password	Changes the password for the current user
Quit	Ends a session
UPSStat	Displays the status of the associated UPS devices

Administrative Command Summary

Add Porttouser	Grants a user access to one or all serial/Pass-Thru ports
Create User	Adds a user account
Delete Portfromuser	Removes access to one or all serial/Pass-Thru ports
List User	Displays all accessible ports for a user
List Users	Displays privilege levels for all users
Remove User	Deletes a user account
Restart	Performs a warm boot
Set Banner	Set the pre-login banner text
Set DHCP	Enables or disables DHCP support
Set DHCP Boot Delay	Enables or disables a 90-second boot delay between CDU and DHCP server
Set DHCP Static Address Fallback	Enables or disables DHCP fallback to a static IP address
Set DNS	Sets the IP address of the Domain Name System (DNS) server
Set Envmon Name	Specifies a descriptive field fro the integrated Environmental Monitor
Set Envmon THS Name	Specifies a descriptive field for a temperature-humidity sensor
Set FTP Autoupdate	Enables or disables automatic FTP update support
Set FTP Autoupdate Day	Sets the automatic FTP update day
Set FTP Autoupdate Hour	Sets the automatic FTP update hour
Set FTP Directory	Specifies the directory for the file to be uploaded
Set FTP Filename	Specifies the file to be uploaded via FTP
Set FTP Filepath	Specifies the directory for the file to be uploaded
Set FTP Host	Sets the FTP Host IP address or hostname
Set FTP Password	Sets the password for the FTP Host
Set FTP Username	Sets the username for the FTP Host
Set FTP Server	Enables or disables the FTP server
Set Gateway	Sets the Gateway of the Sentry
Set HTTP	Enables or disables HTTP access and sets the HTTP target port.
Set HTTP Port	Specifies the target port for HTTP access
Set Infeed Name	Specifies a descriptive field for the infeed
Set IPAddress	Sets the IP address of the Sentry
Set Infeed Loadmax	Specifies the maximum load capacity for the infeed
Set Infeed Voltage	Specifies the nominal input voltage for the infeed
Set LDAP UseTLS	Enables or disables LDAP over TLS/SSL support
Set Location	Specifies a descriptive field for the HTML control screen and login banner
Set Option Button	Enables or disables the external configuration reset button
Set Option Coldboot Alert	Enables or disables the Coldboot Alert feature using a serial protocol
Set Option Display	Sets the LED orientation for external Current displays
Set Option More	Enables or disables the 'more' prompt
Set Option StrongPasswords	Enables or disables strong password requirements
Set Option Tempscale	Sets the Environmental Monitor temperature scale
Set Option CLI Timeout	Sets the Command Line Interface (CLI) session timeout period
Set Option Web Timeout	Sets the web session (Web Interface) timeout period
Set Port Name	Specifies a descriptive field for a serial/Pass-Thru port
Set Port DSR Check	Sets the DSR active signal checking for a serial/Pass-Thru port
Set Port Speed	Set the connection speed for all serial/Pass-Thru ports
Set Port Timeout	Sets the inactivity timer for Pass-Thru sessions

Administrative Command Summary (continued...)

Set SNMP IPRestrict	Allows SNMP GET and SET requests from defined traps destinations only
Set SNTP	Sets the IP address or hostname of the SNTP servers
Set SNTP GMTOffset	Sets the local GMT offset applied to the SNTP date/time
Set Subnet	Sets the Subnet Mask of the Sentry
Set System Area	Specifies to total system area for the system
Set System Area Unit	Specifies the system area (footprint) unit of measure
Set System Balance	Sets the percent load out-of-balance threshold for 3-phase systems
Set System PF	Sets the power factor used in the total system power calculation
Set Telnet	Enables or disables Telnet access
Set Telnet Port	Sets the Telnet server port number
Set Tower 3Phase	Specifies the AC voltage type for the tower
Set Tower Model	Specifies the model number for the tower
Set Tower Name	Specifies a descriptive field for the Sentry
Set Tower ProdSN	Specifies the serial number for the tower
Set Tower	Specifies the AC or DC voltage type for the tower
Set User Access	Sets the access level for a user
Set User Envmon	Grants or removes privileges to view input/environmental monitoring status
Set User Password	Changes the password for a user
Set UPS AddInfeed	Adds an infeed association to a UPS
Set UPS DelInfeed	Deletes an infeed association from a UPS
Set UPS GETComm	Sets the UPS 'get' community string
Set UPS Host	Sets the UPS Host IP address or hostname
Set UPS Port	Specifies the target port for a UPS
Set UPS Type	Sets the UPS type
Set UPS VPoll	Enables or disables UPS voltage polling
Show FTP	Displays FTP configuration information
Show Infeeds	Displays infeed configuration information
Show Network	Displays network configuration information
Show Options	Displays system option information
Show Ports	Displays serial/Pass-Thru port configuration information
Show SNTP	Displays SNTP configuration information
Show System	Displays system configuration information
Show Towers	Displays tower configuration information
Show UPS	Displays UPS configuration information
System Status	Displays system status configuration information
Version	Displays the Sentry firmware version

To display the names of commands that you can execute:

At the command prompt, press **Enter**. A list of valid commands for the current user appears.

Operations Commands

Operations commands manage outlet states, provide information about the Sentry environment and control session operations.

Displaying infeed status:

The IStat command displays the status of one or more infeeds.

This display includes the infeed absolute and descriptive names and the Input Status and current Load reported to the Sentry by the infeed, branch, or phase.

To display status of one or more infeeds:

Type **istat** and press **Enter**, or

Examples

The following command displays the infeed status:

```
Smart CDU: istat

  Input      Input      Input      Input
  Feed ID    Feed Name    Status     Load
  .AA        HQ_1_Infeed_A    On         10.5 Amps
```

Connecting to a serial device:

The Connect command allows Pass-Thru serial connection to devices attached to the standard serial port (Console).

To connect to a serial device:

At the Smart CDU: prompt, type **connect console** and press **Enter**.

To disconnect from a serial device:

Type **!*break** and press **Enter**.

Displaying the status of the Environmental Monitor:

The Envmon command displays the status of the integrated Environmental Monitor.

By default, only administrative user accounts are allowed access to the Envmon command. An administrator may use the Set User Envmon command to enable and disable access for other user accounts.

To display the status of the Environmental Monitor:

At the Smart CDU: prompt, type **envmon** and press **Enter**.

Example

The following command displays the status of the Environmental Monitor.

```
Smart CDU: envmon<Enter>
Environmental Monitor .A
Name: Florida_HQ_1          Status: Normal
Temperature/Humidity Sensors
  ID      Name                Temperature  Humidity
  .A1     Temp_Humid_Sensor_A1  Not Found   Not Found
  .A2     T/H2_Florida_HQ_1     23.5 Deg. C  22 % RH
```

Changing a password:

The Password command changes the current user's password. For security, when you type a password, the characters are not displayed on the screen.

To change a password:

At the Smart CDU: prompt, type **password** and press **Enter**.

At the Enter Current Password: prompt, type the current password and press **Enter**.

At the Enter New Password: prompt, type the new password and press **Enter**. Passwords may contain 1-16 characters.

At the Verify Password: prompt, retype the new password and press **Enter**.

Starting a new session:

The Login command activates the Username: prompt. The current session ends, allowing a user to log in and start a new session under a different username.

To start a new session:

At the Smart CDU: prompt, type **login** and press **Enter**. The Username: prompt appears.

Ending a session:

The Quit or Logout commands ends a session. A session ends automatically when no activity is detected for five minutes, or upon loss of connection.

To end a session:

At the Smart CDU: prompt, type **quit** and press **Enter**, or

Type **logout** and press **Enter**.

Displaying UPS status:

The UPSStat command displays the status of one or more UPS devices associated with the Sentry unit.

The display includes UPS index number, type, line/battery status, and reported voltage.

NOTE: Access to this command requires enabling user privileges for environmental monitoring using the Set User Envmon command.

To display status of one or more UPS devices:

At the Smart CDU: prompt, type **upsstat** and press **Enter**.

Example

The following command displays the UPS status:

```
Smart CDU: upsstat<Enter>
  UPS      UPS      UPS      UPS
  Index    Type      Status   Voltage
  1        Generic(RFC1628) N/A      N/A
  2        Liebert    On Battery 120.0
  3        MGE      On Utility 119.9
```

Administration Commands

Administration commands may only be issued by a user with administrative privileges, such as the predefined Admn user or another user who has been granted administrative privileges with the Set User Admnpriv command.

User Administration

Creating a user account:

The Create User command creates a user account with the specified username and password.

To create a user account:

At the Smart CDU: prompt, type **create user**, optionally followed by a 1-16 character username (Spaces are not allowed, and usernames are not case sensitive). Press **Enter**.

At the Password: prompt, type a password of 1-16 alphanumeric and other typed characters - (ASCII 33 to 126 decimal) are allowed; passwords are case sensitive. Press **Enter**.

At the Verify Password: prompt, retype the password. Press **Enter**.

Example

The following command creates the user account JaneDoe:

```
Smart CDU: create user JaneDoe<Enter>
Password: <Enter>
Verify New Password: <Enter>
```

For security, password characters are not displayed.

Removing a user account:

The Remove User command removes a user account.

NOTE: You may remove the predefined user account Admn only if another user account has been granted administrative privileges using the Set User Admnpriv command.

To remove a user account:

At the Smart CDU: prompt, type **remove user**, optionally followed by a username. Press **Enter**.

Changing a password:

The Set User Password command changes a user's password. For security, when you type a password, the characters are not displayed on the screen.

To change a password:

At the Smart CDU: prompt, type **set user password**, followed by a username and press **Enter**.

At the Password: prompt, type the new password and press **Enter**. Passwords may contain 1-16 characters.

At the Verify Password: prompt, retype the new password and press **Enter**.

Example

The following command changes the password for the user JohnDoe:

```
Smart CDU: set user password johndoe<Enter>
Password: <Enter>
Verify Password: <Enter>
```

For security, password characters are not displayed.

Setting user access level privileges:

The Set User Access command sets the access level for a user. The Sentry user access levels are Admin, Power, and User. For more information about user access levels, see [Changing a User's Access Privilege Level](#) on page 29.

The administrator can also grant administrative privileges to other user accounts allowing the Sentry to have more than one administrative-level user.

NOTE: You cannot remove administrative privileges from the **admin** user unless another user has already been given administrative access level privileges created.

To set the access level privilege for a user:

At the Smart CDU: prompt, type **set user access**, followed by **admin**, **poweruser**, **user**, **rebootonly**, **ononly** or **viewonly**, optionally followed by a username and press **Enter**.

Examples

The following command sets the user access level for JohnDoe to Admin:

```
Smart CDU: set user access admin johndoe<Enter>
```

The following command sets the user access level for JaneDoe to User:

```
Smart CDU: set user access user janedoe<Enter>
```

Displaying the access privilege levels:

The List Users command displays all defined users with their access privilege level.

To display user access privilege levels:

At the Smart CDU: prompt, type **list users** and press **Enter**.

Example

The following command displays all users with their access privilege level:

```
Smart CDU: list users<Enter>
  User          Privilege   Environmental
  Name          Level       Monitoring
  JOHNDOE       Admin      Allowed
  JANEDOE       User       Allowed
```

Adding serial port access to a user:

The Add PortToUser command grants a user access to the serial port.

To grant serial port access to a user:

At the Smart CDU: prompt, type **add porttouser console** and a username. Press **Enter**.

Deleting serial port access for a user:

The Delete PortFromUser command removes a user's access to the serial port. You cannot remove access to the serial port for an administrative level user.

To delete serial port access for a user:

At the Smart CDU: prompt, type **delete portfromuser console** and a username. Press **Enter**.

Displaying user serial port access:

The List User command displays all accessible outlets, groups and serial ports for a user.

To display serial port access:

At the Smart CDU: prompt, type **list user**, optionally followed by a username. Press **Enter**.

Example

The following command displays information about the user JaneDoe:

```
Smart CDU: list user janedoe<Enter>
  Username: JANEDOE
  Ports:
    Port      Port
    ID        Name
  Console    Console
```

Input Feed Administration

Creating a descriptive infeed name:

The Set Infeed Name command assigns a descriptive name to an infeed. This descriptive name is displayed when the Show Traps command is issued. For more information about the Show Traps command, see Displaying Trap Configuration Information on page 80.

To create a infeed name:

At the Smart CDU: prompt, type **set infeed name** followed by the absolute infeed name, then a descriptive name of up to 24 alphanumeric and other typed characters - (ASCII 33 to 126 decimal) are allowed; spaces are not allowed. Press **Enter**.

Example

The following command adds the descriptive name HQ_1_Infeed_A to the infeed on the Smart POPS CDU:

```
Smart CDU: set infeed name .aa HQ_1_Infeed_A<Enter>
```

Setting the infeed operational voltage

The Set Infeed Voltage command is use to edit the input operational voltage.

To set the infeed operational voltage:

At the Smart CDU: prompt, type **set infeed voltage**, followed by the absolute infeed name, and a value from 0 to 480. Press **Enter**.

Example

The following commands sets the operational voltage for input .AA to 100V:

```
Smart CDU: set infeed voltage .aa 100<Enter>
```

Setting the infeed maximum load capacity

The Set Infeed LoadMax command is use to edit the input maximum load capacity.

To set the infeed maximum load capacity:

At the Smart CDU: prompt, type **set infeed loadmax**, followed by the absolute infeed name, and a value from 1 to 255 (in amperes). Press **Enter**.

Example

The following commands sets the maximum load capacity for input .AA to 15 amperes:

```
Smart CDU: set infeed loadmax .aa 15<Enter>
```

Displaying infeed information:

The Show Infeeds command displays information about all infeeds. This information includes the absolute and descriptive infeed names, operational voltages and maximum load capacities.

To display tower information:

At the Smart CDU: prompt, type **show infeeds** and press **Enter**.

Example

```
Smart CDU: show infeeds<Enter>
```

Input Feed ID	Input Feed Name	Input Feed Voltage	Input Feed Capacity (Amps)
.AA	HQ_1_Infeed_A	100	15
.AB	HQ_1_Infeed_B	120	20
.BA	HQ_2_Infeed_A	120	30
.BB	HQ_2_Infeed_B	120	30

Tower Administration

Creating a descriptive tower name:

The Set Tower Name command assigns a descriptive name to a tower. This descriptive name is displayed when the Show Traps command is issued. For more information about the Show Traps command, see Displaying Trap Configuration Information on page 80.

To create a tower name:

At the Smart CDU: prompt, type **set tower name** followed by the absolute tower name, then a descriptive name of up to 24 alphanumeric and other typed characters - (ASCII 33 to 126 decimal) are allowed; spaces are not allowed. Press **Enter**.

Example

The following command adds the descriptive name Florida_HQ_1 to tower .a:

```
Smart CDU: set tower name .a Florida_HQ_1<Enter>
```

Setting the tower serial number:

The Set Tower Prodsn command is use to set the product serial number.

NOTE: If set at the factory, the serial number WILL NOT be user-editable.

To set the tower serial number:

At the Smart CDU: prompt, type **set tower prodsn**, followed by the absolute tower name, and the tower serial number. Press **Enter**.

Example

The following command sets the serial number for tower .A to 'AA06F011157':

```
Smart CDU: set tower prodsn .a AA06F011157<Enter>
```

Setting the tower model number:

The Set Tower Model command is use to set the product model number.

NOTE: If set at the factory, the model number WILL NOT be user-editable.

To set the tower model number:

At the Smart CDU: prompt, type **set tower model**, followed by the absolute tower name, and the tower model number. Press **Enter**.

Example

The following command sets the model number for tower .A to 'CS-24V2-C20':

```
Smart CDU: set tower prodsn .a CS-24V2-C20<Enter>
```

Setting the tower AC or DC voltage type:

The Set Tower command is used to set the product input AC or DC voltage type.

NOTE: If set at the factory, the voltage type WILL NOT be user-editable.

To set the tower AC/DC voltage type:

At the Smart CDU: prompt, type **set tower**, followed by **ac** or **dc**, and the absolute tower name. Press **Enter**.

Example

The following command sets the AC/DC voltage type for tower .A to AC:

```
Smart CDU: set tower ac.a<Enter>
```

Setting the tower AC voltage type:

The Set Tower 3phase command is used to set the product input AC voltage type.

NOTE: If set at the factory, the voltage type WILL NOT be user-editable.

To set the tower AC voltage type:

At the Smart CDU: prompt, type **set tower 3phase**, followed by the absolute tower name and **yes** or **no**. Press **Enter**.

Example

The following command sets the AC voltage type for tower .A to non-3-phase:

```
Smart CDU: set tower 3phase.a no<Enter>
```

Displaying tower information:

The Show Towers command displays information about the Sentry. This information includes the absolute and descriptive Sentry names, serial and model numbers, and voltage types.

To display tower information:

At the Smart CDU: prompt, type **show towers** and press **Enter**.

Example

```
Smart CDU: show towers<Enter>
Tower ID:      .A
Name:         TowerA
Product S/N:   AA06F011157
Model No.:    CS-24V2-C20
3-Phase:      No
Power Type:    AC

More (Y/es N/o):
```

Environmental Monitor Administration

Creating a descriptive Environmental Monitor name:

The Set Envmon Name command assigns a descriptive name to the integrated Environmental Monitor. This descriptive name is displayed when the Evnmon command is issued.

To create an Environmental Monitor name:

At the Smart CDU: prompt, type **set envmon name** followed by the absolute environmental monitor name, then a descriptive name of up to 24 alphanumeric and other typed characters - (ASCII 33 to 126 decimal) are allowed; spaces are not allowed. Press **Enter**.

Example

The following command adds the descriptive name Florida_HQ_1 to the Environmental Monitor:

```
Smart CDU: set envmon name .a Florida_HQ_1<Enter>
```

Creating a descriptive temperature/humidity sensor name:

The Set Envmon THS Name command assigns a descriptive name to a temperature/humidity sensor. This descriptive name is displayed when the Evnmon command is issued.

To create a temperature/humidity sensor name:

At the Smart CDU: prompt, type **set envmon ths name** followed by the absolute name of the temperature/humidity sensor, then a descriptive name of up to 24 alphanumeric and other typed characters - (ASCII 33 to 126 decimal) are allowed; spaces are not allowed. Press **Enter**.

Example

The following command adds the descriptive name T/H2_Florida_HQ_1 to the second temperature/humidity sensor:

```
Smart CDU: set envmon ths name .a2 T/H2_Florida_HQ_1<Enter>
```

Serial Port Administration

Creating a descriptive serial port name:

The Set Port Name command assigns a descriptive name to a serial port. You may use this name in commands that require a port name as an alternative to using the port's absolute name.

To create a port name:

At the Smart CDU: prompt, type **set port name** followed by the absolute outlet name, then a descriptive name of up to 24 alphanumeric and other typed characters - (ASCII 33 to 126 decimal) are allowed; spaces are not allowed; port names are not case sensitive. Press **Enter**.

Example

The following command adds the descriptive name Rack1 to Console port:

```
Smart CDU: set port name console Rack1<Enter>
```

Setting the serial ports data-rate:

The Set Port Speed command sets the default data-rate for the serial port. Valid data-rates are 1200, 2400, 4800, 9600, 19200, 38400, 57600 and 115200.

To set the serial port data-rate:

At the Smart CDU: prompt, type **set port speed**, follow by the data-rate and press **Enter**.

Example

The following command sets the serial ports data-rate to 38400 BPS:

```
Smart CDU: set port speed 38400<Enter>
```

Enabling or disabling active signal checking for serial connections:

The Set Port DSR Check command enables or disables active signal checking for serial connections to devices attached to any of the available serial ports.

To enable or disable active signal checking for serial connections:

At the Smart CDU: prompt, type **set port dsrchk console, on or off**, and press **Enter**.

Setting the serial port timeout value:

The Set Port Timeout command is used to set the serial port inactivity timeout period. The timeout period defines the maximum period of inactivity before automatically closing the Pass-Thru session. The valid range for the period parameter is 0 to 5 (in minutes). The default period is 5.

NOTE: Setting the timeout to '0' disables the timer.

To set the serial port timeout value:

At the Smart CDU: prompt, type **set port timeout**, followed by a value from 0 to 5 (in minutes) and press **Enter**.

Displaying serial port information:

The Show Ports command displays information about all serial ports. This information includes:

- Serial port data rate
- Descriptive port name, if applicable
- DSR signal checking settings

To display serial port information:

At the Smart CDU: prompt, type **show ports** and press **Enter**.

Example

The following command displays all serial port information:

```
Smart CDU: show ports<Enter>
Serial Port Configuration
ALL Ports:
  Baud Rate: 38400      Connection Timeout: 5 minutes
  Port ID: Console     Port Name: CONSOLE
  DSR Check: ON
```

System Administration

Creating a pre-login banner:

The Set Banner command specifies text that appears prior to the login authentication. This feature allows administrators to configure a message up to 2069 characters for display of legal, disclaimer or other text as required by application. If left blank, the user will be taken directly to the login prompt.

NOTE: For SSH sessions, the 'keyboard-interactive' authentication method must be used for the banner to display.

To create a pre-login banner:

At the Smart CDU: prompt, type **set banner** and press **Enter**. Type the desired pre-login banner text and when finished type **Ctrl-z**.

Creating a location description:

The Set Location command specifies text that appears in the HTML control screen's Location field. The text is also appended to a Welcome to banner that appears when a user successfully logs in serially or through a Telnet session.

If you do not issue this command, or if you issue this command without specifying any text, the control screen's Location field will be blank and no Welcome to banner will be displayed.

To create a location description:

At the Smart CDU: prompt, type **set location** followed by a descriptive name of up to 24 alphanumeric and other typed characters - (ASCII 33 to 126 decimal) are allowed; spaces are allowed. Press **Enter**.

Omitting any characters after typing 'set location' deletes any previously specified text.

Examples

The following command specifies Florida HQ as the descriptive location for the control screen and the login banner:

```
Smart CDU: set location Florida HQ<Enter>
```

The following command deletes any previously specified location description:

```
Smart CDU: set location<Enter>
```

In this case, the control screen's Location field will be blank, and no welcome banner will be displayed after a successful login.

Displaying system configuration information:

The Show System command displays all system configuration information.

- Firmware version
- NIC module serial number and MAC address
- Hardware revision code and Flash size
- Uptime since last system restart
- System location description

For more information, see SNMP in Chapter 4: Advanced Operations on page 69.

To display system configuration information:

At the Smart CDU: prompt, type **show system** and press **Enter**.

Example

```
System Information
  F/W Version:      Sentry Version 5.2b
  NIC S/N:          1600001
  MAC Address:      00-0a-9c-10-00-01
  H/W Rev Code:     0
  Flash Size:       1 MB
  Uptime:           0 days 6 hours 14 minutes 1 second
  Location:         Florida HQ
  Area <Footprint>: 95.5 square meters
  Power Factor:     0.90

  3-Phase Load
  Out-of-Balance
  Threshold:        15 percent
```

Displaying system power status:

The System Status command displays all power status information.

To display system power status:

At the Smart CDU: prompt, type **sysstat** and press **Enter**.

Example

```
Smart CDU: sysstat
System Power Status
Total Power Consumption: 170 Watts
Area <Footprint>: 100.0 Square Meters
Watts Per Area Unit: 2 Watts Per Square Meter
```

Setting the LED display orientation:

The Set Option Display command is used to configure the Current LED(s) display orientation.

To set the LED display orientation:

At the Smart CDU: prompt, type **set option display**, followed by **normal** or **inverted** and press **Enter**.

Example

The following set the LED display orientation to Inverted:

```
Smart CDU: set option display inverted<Enter>
```

NOTE: When set to Inverted, the load will be reported in whole ampere increments

Enabling or disabling strong passwords:

The Set Option Strong Password command is used to enable or disable the requirements for strong passwords. When enabled, all new passwords must be a minimum of 8 characters in length with at least one uppercase letter, one lowercase letter, one number and one special character.

To enable or disable strong passwords:

At the Smart CDU: prompt, type **set option strong password**, followed by **enabled** or **disabled** and press **Enter**.

Enabling or disabling the external configuration reset button:

The Set Option Button command enables or disables the external configuration reset button. This feature can enhance system security by protecting the Sentry configurations from being reset locally.

NOTE: If this feature has been enabled and the administrative account username/password has been lost, then the Sentry must be returned to the factory for non-warranty reset of the configuration.

To enable or disable the configuration reset button:

At the Smart CDU: prompt, type **set option button**, followed by **enabled** or **disabled** and press **Enter**.

Enabling or disabling the 'more' prompt:

The Set Option More command enables or disables the 'more' prompt for display of data larger than the terminal window.

To enable or disable 'more':

At the Smart CDU: prompt, type **set option more**, followed by **enabled** or **disabled** and press **Enter**.

Setting the temperature scale:

The Set Option TempScale command sets the temperature scale that the Sentry will report in.

To set the temperature scale:

At the Smart CDU: prompt, type **set option tempscale**, followed by **celsius** or **fahrenheit** and press **Enter**.

Displaying system options:

The Show Options command displays all system option information.

To display system option information:

At the Smart CDU: prompt, type **show options** and press **Enter**.

Example

```
Smart CDU: show options
System Options
  Display Orientation:      NORMAL
  Strong Passwords:       DISABLED
  Configuration Reset Button: ENABLED
  More Prompt:            ENABLED
  Temperature Scale:      CELSIUS
  CLI Session Timeout:    10 minutes
  Web Session Timeout:    10 minutes
  Coldboot Alert <SCP>:   DISABLED
```

Setting the system area :

The Set System Area command specifies the numeric value for the system area that is used to calculate total system watts per area unit.

To set the system area:

At the Smart CDU: prompt, type **set system area**, followed by a value (0.0-100.0), and press **Enter**.

Example:

The following command sets the system area to 95.5:

```
Smart CDU: set system area 95.5<Enter>
```

Setting the system area unit of measure:

The Set System Area Unit command sets the value for the system area footprint in either square meters or square feet.

The default unit of area is a square meter.

To set the system area unit of measure:

At the Smart CDU: prompt, type **set system areaunit**, followed by **squaremeter** or **squarefoot**, and press **Enter**.

Setting the power factor:

The Set System PF command sets the power factor used in the total system power calculation. The valid range is .50 to 1.00.

To set the power factor:

At the Smart CDU: prompt type **set system pf**, followed by the power factor, and press **Enter**.

Setting the 3-phase load out-of-balance threshold:

The Set System Balance command sets the percent load out-of-balance threshold for 3-phase systems.

To set the 3-phase load out-of-balance threshold:

At the Smart CDU: prompt, type **set system balance**, followed by the load out-of-balance threshold (in percent), and press **Enter**.

Example:

The following command sets the 3-phase load out-of-balance threshold to 15%.

```
Smart CDU: set system balance 15<Enter>
```

Creating a descriptive tower name:

The Set Tower Name command assigns a descriptive name to a tower. This descriptive name is displayed when the Show Traps command is issued. For more information about the Show Traps command, see Displaying Trap Configuration Information on page 80.

To create a tower name:

At the Smart CDU: prompt, type **set tower name** followed by the absolute tower name, then a descriptive name of up to 24 alphanumeric and other typed characters - (ASCII 33 to 126 decimal) are allowed; spaces are not allowed. Press **Enter**.

Example

The following command adds the descriptive name Florida_HQ_1 to tower .a:

```
Smart CDU: set tower name .a Florida_HQ_1<Enter>
```

Displaying tower information:

The Show Towers command displays information about the Sentry. This information includes the absolute and descriptive Sentry names.

To display tower information:

At the Smart CDU: prompt, type **show towers** and press **Enter**.

Example

```
Smart CDU: show towers<Enter>
Tower   Tower
ID      Name
.A      Florida_HQ_1
```

Creating a descriptive infeed name:

The Set Infeed Name command assigns a descriptive name to an infeed. This descriptive name is displayed when the Show Traps command is issued.

To create an infeed name:

At the Smart CDU: prompt, type **set infeed name** followed by the absolute infeed name, then a descriptive name of up to 24 alphanumeric and other typed characters - (ASCII 33 to 126 decimal) are allowed; spaces are not allowed. Press **Enter**.

Example

The following command adds the descriptive name HQ_1_Infeed_A to the infeed on the Smart POPS CDU:

```
Smart CDU: set infeed name .aa HQ_1_Infeed_A<Enter>
```

Displaying infeed information:

The Show Infeeds command displays information about all infeeds. This information includes the absolute and descriptive infeed names.

To display tower information:

At the Smart CDU: prompt, type **show infeeds** and press **Enter**.

Example

```
Smart CDU: show infeeds<Enter>
Input   Input
Feed ID Feed Name
.AA     HQ_1_Infeed_A
.AB     HQ_1_Infeed_B
.BA     HQ_2_Infeed_A
.BB     HQ_2_Infeed_B
```

Displaying the Sentry firmware version:

The Version command displays the Sentry firmware version.

To display the firmware version:

At the Smart CDU: prompt, type **version** and press **Enter**.

Performing a warm boot:

The Restart command performs a warm boot of the Sentry.

NOTE: System user/outlet/group/port configuration or outlet states are NOT changed or reset with this command.

To perform a warm boot:

At the Smart CDU: prompt, type **restart** and press **Enter**.

TCP/IP Administration

NOTE: A restart of the Sentry is required after setting or changing ANY TCP/IP configurations. For more information, see *Performing a warm boot* on page 57.

Enabling or disabling DHCP support:

The Set DHCP command enables or disables DHCP support.

To enable or disable DHCP support:

At the Smart CDU: prompt, type **set dhcp**, followed by **enabled** or **disabled**, and press **Enter**.

Enabling or disabling DHCP boot delay:

NOTE: DHCP must be enabled to activate the DHCP Boot Delay option.

The Set DHCP Boot Delay command enables or disables the DHCP boot delay option.

Enabling the Boot Delay option gives the CDU approximately 90-seconds to establish a connection through a DHCP server. This interval allows various network component activities to occur as the CDU powers up (such as obtaining SNTP time stamps for logging). This is the default state.

Disabling the Boot Delay option forces the CDU to boot after approximately 5-seconds regardless of the DHCP acquisition state. This speeds up a boot when a DHCP server is connected to one of the CDU's outlets. In this configuration, SNMP traps, SNTP and other protocols will not be available until a DHCP address has been resolved.

To enable the boot delay:

At the Smart CDU: prompt, type **set dhcp**, followed by **bootdelay**, followed by **enabled** or **disabled**, and press **Enter**.

Enabling or disabling DHCP static address fallback:

NOTE: DHCP must be enabled to activate the DHCP Static Address Fallback option.

The Set DHCP Static Address Fallback command enables or disables the DHCP static address fallback option.

Enabling the Static Address Fallback option informs the CDU to automatically fall back to a static address if a DHCP server does not respond after 90-seconds. This is the default state.

Disabling the Static Address Fallback option generates periodic DHCP server requests until the CDU obtains a dynamic address.

To enable the static address fallback:

At the Smart CDU: prompt, type **set dhcp**, followed by **staticfallback**, followed by **enabled** or **disabled**, and press **Enter**.

NOTE: If the DHCP server boot time is excessive, you may need to disable the DHCP Static Address Fallback option.

Setting the IP address:

The Set IPAddress command sets the TCP/IP address of the network interface controller.

To set the IP address:

At the Smart CDU: prompt, type **set ipaddress**, followed by the IP address and press **Enter**.

Example

The following command sets the IP address to 12.34.56.78:

```
Smart CDU: set ipaddress 12.34.56.78<Enter>
```

Setting the subnet mask:

The Set Subnet command sets the subnet mask for the network the PT40 will be attached to.

To set the subnet mask:

At the Smart CDU: prompt, type **set subnet**, followed by the subnet mask and press **Enter**.

Example

The following command sets the subnet mask to 255.0.0.0

```
Smart CDU: set subnet 255.0.0.0<Enter>
```

Setting the gateway:

The Set Gateway command sets the IP address of the default gateway the Sentry uses to access external networks.

To set the gateway IP address:

At the Smart CDU: prompt, type **set gateway**, followed by the gateway IP address and press **Enter**.

Example

The following command set the gateway IP address to 12.34.56.1:

```
Smart CDU: set gateway 12.34.56.1<Enter>
```

Setting the DNS IP address:

The Set DNS command sets the TCP/IP address of the Domain Name System (DNS) server.

To set the DNS IP address:

At the Smart CDU: prompt, type **set**, followed by **dns1** or **dns2** and the Domain Name System (DNS) server's IP address. Press **Enter**.

Example

The following command sets the primary Domain Name System (DNS) server IP address to 98.76.54.254:

```
Smart CDU: set dns1 98.76.54.254<Enter>
```

Displaying network configuration information:

The Show Network command displays TCP/IP, Telnet, SSH, Web, SSL, SNMP, and DHCP options (when DHCP is enabled) configuration information.

- Network configuration: IP address, subnet mask, gateway and DNS IP addresses.
- Enabled-disabled status and port numbers for Telnet, SSH, HTTP, SSL, SNMP, and FTP Server support.
- Network status: Link, speed, duplex, and negotiation.
- DHCP boot delay and DHCP static address fallback options (when DHCP is enabled).

To display network configuration information:

At the Smart CDU: prompt, type **show network** and press **Enter**.

Example

The following command displays the network configuration information:

```
Smart CDU: show network<Enter>
Network Configuration
  IP Address:      12.34.56.78                DNS1: 98.76.54.254
  Subnet Mask:    255.0.0.0                  DNS2: 0.0.0.0
  Gateway:        12.34.56.1                DHCP: Enabled
  DHCP Options:  Static address fallback enabled, boot delay enabled
  Telnet:         Enabled                    Port: 23
  SSH:           Enabled                    Port: 65535    Auth: Password, Kb-Int
  HTTP:          Enabled                    Port: 8
  SSL:           Enabled
  SNMP:          Enabled                    Access: Optional
  FTP Server:    Enabled
Network Status
  Link:          Up
  Speed:         100 Mbps
  Duplex:        Full
  Negotiation:   Auto
```

HTTP Administration

NOTE: A restart is required after setting or changing ANY Telnet/Web configurations. For more information, see *Performing a warm boot* on page 57.

Enabling and disabling HTTP support:

The Set HTTP command is used to enable or disable HTTP support.

To enable or disable HTTP support:

At the Smart CDU: prompt, type **set http**, followed by **enabled** or **disabled** and press **Enter**.

Changing the HTTP server port:

With HTTP support enabled, the HTTP server watches and responds to requests on the default HTTP port number 80. This port number may be changed using the Set HTTP Port command.

To change the HTTP port:

At the Smart CDU: prompt, type **set http port**, followed by the port number and press **Enter**.

Example

The following changes the HTTP port number to 2048:

```
Smart CDU: set HTTP port 2048<Enter>
```

Sentry Power Manager (SPM) Administration:

The Sentry Power Manager (SPM) is Server Technology's enterprise management software product for the data center. The configuration options provided allow you to enable/disable SPM and reset the SPM password to its default.

NOTE: The SPM options only apply if you are currently using Server Technology's SPM software. In addition, the SPM options are only available on the HTTP/SSL web page. There are no equivalent SPM options on the Command Line Interface (CLI). To configure the SPM options, see the Web interface [HTTP/SSL](#) web page.

Telnet Administration

NOTE: A restart of the Sentry is required after setting or changing ANY Telnet/Web configurations. For more information, see *Performing a warm boot* on page 57.

Enabling and disabling Telnet support:

The Set Telnet command is used to enable or disable Telnet support.

To enable or disable Telnet support:

At the Smart CDU: prompt, type **set telnet**, followed by **enabled** or **disabled** and press **Enter**.

Changing the Telnet port:

With Telnet support enabled, the Telnet server watches and responds to requests on the default Telnet port number 23. This port number may be changed using the Set Telnet Port command.

To change the Telnet socket:

At the Smart CDU: prompt, type **set telnet port**, followed by the port number and press **Enter**.

Example

The following changes the Telnet port number to 7001:

```
Smart CDU: set telnet port 7001<Enter>
```

FTP Administration

You may upload new versions of firmware into the Sentry using File Transfer Protocol (FTP). This allows access to new firmware releases for firmware improvements and new features additions. The following commands are used to configure the Sentry for an FTP firmware upload. For more information about initiating FTP firmware uploads, see Appendix B: Uploading Firmware on page 104.

Setting the FTP host address:

The Set FTP Host command sets the FTP host IP address or hostname allowing for firmware file uploads.

To set the FTP Host address:

At the Smart CDU: prompt, type **set ftp host**, followed by the IP address or hostname and press **Enter**.

Examples

The following command sets the FTP host IP address to 12.34.56.99:

```
Smart CDU: set ftp host 12.34.56.99<Enter>
```

The following command sets the FTP hostname to ftp.servertech.com:

```
Smart CDU: set ftp host ftp.servertech.com<Enter>
```

Setting the FTP username:

The Set FTP Username command sets the username as required by the FTP Host.

To set the FTP username:

At the Smart CDU: prompt, type **set ftp username**, followed by the FTP username and press **Enter**.

Example

The following command sets the FTP username to Guest:

```
Smart CDU: set ftp username guest<Enter>
```

Setting the FTP Password:

The Set FTP Password command sets the password as required by the FTP Host.

To set the FTP password:

At the Smart CDU: prompt, type **set ftp password**, followed by the FTP password and press **Enter**.

Example

The following command sets the FTP password to OpenDoor:

```
Smart CDU: set ftp password OpenDoor<Enter>
```

Setting the filename to be uploaded:

The Set FTP Filename command sets the filename of the firmware file to be uploaded.

To set the FTP filename:

At the Smart CDU: prompt, type **set ftp filename**, followed by the firmware filename and press **Enter**.

Example

The following command sets the FTP filename to snb_s50a.bin:

```
Smart CDU: set ftp filename smcdu-v60g.bin<Enter>
```

Setting the directory for the file to be uploaded:

The Set FTP Directory or Set FTP Filepath commands set the directory for the firmware file to be uploaded.

To set the FTP directory:

At the Sentry: prompt, type **set ftp directory**, followed by the directory and press **Enter**.

Or, type **set ftp filepath**, followed by the directory and press **Enter**

Example

The following command sets the FTP directory to ftp://Sentry:

```
Sentry: set ftp directory ftp://sentry<Enter>
```

Enabling or disabling automatic updates:

The Set FTP Autoupdate command is used to enable or disable automatic firmware update support.

To enable or disable automatic updates:

At the Smart CDU: prompt, type **set ftp autoupdate**, followed by **enabled** or **disabled** and press **Enter**.

Setting the automatic update scheduled day:

The Set FTP Autoupdate Day command is used to set the day when automatic updates occur.

To set the automatic update day:

At the Smart CDU: prompt, type **set ftp autoupdate day**, followed by a day of the week or **everyday** and press **Enter**.

Example

The following command sets the automatic update day to Sunday:

```
Smart CDU: set ftp autoupdate day sunday<Enter>
```

Setting the automatic update scheduled hour:

The Set FTP Autoupdate Hour command is used to hour of the day when automatic updates occur.

To set the automatic update hour:

At the Smart CDU: prompt, type **set ftp autoupdate hour**, followed by an hour of the day and press **Enter**.

Examples

The following command sets the automatic update hour to 12 AM:

```
Smart CDU: set ftp autoupdate hour 12am<Enter>
```

The following command sets the automatic update hour to 3 PM:

```
Smart CDU: set ftp autoupdate hour 3pm<Enter>
```

Displaying FTP configuration information:

The Show FTP command displays all FTP configuration information.

- FTP Host IP address
- FTP Host username and password
- Firmware filepath and filename

To display FTP configuration information:

At the Smart CDU: prompt, type **show ftp** and press **Enter**.

Example

The following command displays the FTP configuration information:

```
Smart CDU: show ftp<Enter>
FTP Configuration
Host:      ftp.servertech.com
Username:  guest
Password:  OpenDoor
Directory: ftp://sentry
Filename:  smcdv-v60g.bin
FTP Automatic Updates Configuration
Automatic Updates: 12.34.56.99
Scheduled Day:     Sunday
Scheduled Hour:    3 PM
```

SNTP Administration

Sentry supports the use of a network time service to provide a synchronized time reference.

Setting the SNTP server address:

The Set SNTP command is used to set the primary and secondary SNTP server addresses.

To set the SNTP server address:

At the Smart CDU: prompt, type **set sntp**, followed by **primary** or **secondary**, and the SNTP server IP address or hostname. Press **Enter**.

Examples

The following command sets the primary SNTP server address to 204.152.184.72:

```
Smart CDU: set sntp primary 204.152.184.72<Enter>
```

The following command sets the secondary SNTP server address to cuckoo.nevada.edu:

```
Smart CDU: set sntp secondary cuckoo.nevada.edu<Enter>
```

Setting the local GMT offset:

The Set SNTP GMToffset command is used to set the offset from GMT for the date/time returned by SNTP. The offset can be configured in whole hours between -12 and 12 hours.

NOTE: The Sentry does not support automatic adjustment for daylight savings.

To set the local GMT offset:

At the Smart CDU: prompt, type **set sntp gmtoffset**, followed by the offset value, and press **Enter**.

Examples

The following command sets the local GMT offset to -12:

```
Smart CDU: set sntp gmtoffset -12<Enter>
```

Displaying SNTP configuration information:

The Show SNTP command displays all SNTP configuration information.

To display SNTP configuration information

At the Smart CDU: prompt, type **show sntp** and press **Enter**.

Example

The following command displays the SNTP configuration information:

```
Smart CDU: show sntp <Enter>
Date/Time (Local GMT Offset -12): 2006-02-21 21:32:48
Primary Host: 204.152.184.72
Secondary Host: cuckoo.nevada.edu
```

UPS Administration

Creating a UPS record:

The Create UPS command adds a new UPS device to the Sentry unit.

To create a UPS record:

At the Smart CDU: prompt, type **create UPS** and press **Enter**.

At the prompt, type the corresponding number from the list of the UPS types and press **Enter**.

At the Host Name: prompt, type the UPS's IP address or hostname and press **Enter**.

Example

The following command creates a UPS record for a Toshiba UPS with the hostname 'DC1Toshiba1':

```
Smart CDU: create ups<Enter>
UPS types:
 1 -- APC
 2 -- Liebert
 3 -- MGE
 4 -- Tripp Lite
 5 -- Generic (RFC1628)
 6 -- Hewlett Packard
 7 -- Minuteman
 8 -- Mitsubishi
 9 -- Powerware
10 -- Toshiba
Select type(1-10): 10<Enter>
Host/IP: DC1Toshiba1<Enter>
```

Removing a UPS record:

The Remove UPS command removes a UPS record.

To remove a UPS record:

At the Smart CDU: prompt, type **remove ups** and press **Enter**.

At the prompt, type the index number of the UPS to be removed and press **Enter**.

Example

The following command removes the UPS record at index 3:

```
Smart CDU: remove ups<Enter>
 1  Type:    Liebert
    Host/IP: DC1Liebert1
 2  Type:    Powerware
    Host/IP: DC1Powerware1
 3  Type:    Toshiba
    Host/IP: DC1Toshiba1
Select UPS(1-8): 3<Enter>
```

Changing the UPS type:

The Set UPS Type command is used to change the type of UPS for each UPS record.

To change a UPS record:

At the Smart CDU: prompt, type **set ups type** and press **Enter**.

At the prompt, type the index number for the UPS record to be changed and press **Enter**.

At the prompt, type the corresponding number from the list of the UPS types and press **Enter**.

Example

The following command changes UPS type for the record at index number 2 to 'MGE':

```
Smart CDU: set ups type<Enter>
 1  Type:    Liebert
    Host/IP: DC1Liebert1
 2  Type:    Powerware
    Host/IP: DC1Powerware1
Select UPS(1-8): 2<Enter>
UPS types:
 1 -- APC
 2 -- Liebert
 3 -- MGE
 4 -- Tripp Lite
 5 -- Generic (RFC1628)
 6 -- Hewlett Packard
 7 -- Minuteman
 8 -- Mitsubishi
 9 -- Powerware
10 -- Toshiba
Select type(1-10): 3<Enter>
```

Changing the UPS host address:

The Set UPS Host command is used to change the IP address or hostname for each UPS record. Hostnames may be up to 60 characters long.

To change a UPS host address:

At the Smart CDU: prompt, type **set ups host** and press **Enter**.

At the prompt, type the index number for the UPS record to be changed and press **Enter**.

At the prompt, type IP address or hostname for the UPS and press **Enter**.

Example

The following command changes UPS hostname for the record at index number 2 to 'DC1MGE1':

```
Smart CDU: set ups host<Enter>
  1  Type:    Liebert
     Host/IP: DC1Liebert1
  2  Type:    MGE
     Host/IP: DC1Powerware1
Select UPS(1-8): 2<Enter>
Host/IP: DC1MGE1<Enter>
```

Changing the UPS SNMP port:

With a UPS record configured, the Sentry sends data requests to the default UPS SNMP port number 161. This port number may be changed using the Set UPS Port command.

To change the UPS SNMP port:

At the Smart CDU: prompt, type **set ups port** and press **Enter**.

At the prompt, type the index number for the UPS record to be changed and press **Enter**.

At the prompt, type the desired port number and press **Enter**.

Example

The following command changes port for the UPS record at index number 1 to '162':

```
Smart CDU: set ups port<Enter>
UPS      UPS
Index   Type      Port
  1     Liebert   161
  2      MGE     161
Select UPS(1-8): 1<Enter>
Port: 162<Enter>
```

Changing the UPS SNMP Get community string:

With a UPS record configured, the Sentry sends data requests to the UPS using the default Get community string of 'public'. This string may be changed using the Set UPS Port command.

NOTE: The GET community string configured on the Sentry MUST match the read-only community string configured on the UPS.

To change a UPS record:

At the Smart CDU: prompt, type **set ups getcomm** and press **Enter**.

At the prompt, type the index number for the UPS record to be c and press **Enter**.

At the prompt, type the Get community string for the UPS and press **Enter**.

Example

The following command changes Get community string for the record at index number 2 to 'readonly':

```
Smart CDU: set ups getcomm<Enter>
UPS      UPS      Community
Index   Type      String
  1     Liebert   public
  2      MGE     public
Select UPS(1-8): 2<Enter>
Community String: readonly<Enter>
```

Enabling/disabling UPS voltage polling:

With a UPS record configured, the Sentry by default enables voltage polling of the UPS. This feature may be enabled or disabled using the Set UPS VPoll command.

To enable/ disable UPS voltage polling:

At the Smart CDU: prompt, type **set ups vpoll** and press **Enter**.

At the prompt, enter the index number for the UPS record to be changed and press **Enter**.

At the prompt, type **on** or **off**, and press **Enter**.

Example

The following command disables voltage polling for the record at index number 2:

```
Smart CDU: set ups vpoll<Enter>
UPS      UPS      Voltage
Index   Type      Polling
1       Liebert    On
2       MGE      On
Select UPS(1-8): 2<Enter>
Voltage Polling: Off<Enter>
```

Adding an infeed to a UPS:

The Set UPS AddInfeed command adds a logical association of an infeed to a UPS.

To add an infeed to a UPS:

At the Smart CDU: prompt, type **set ups addinfeed** and press **Enter**.

At the prompt, enter the index number for the UPS record to be changed and press **Enter**.

At the prompt, type the absolute infeed ID of the desired infeed, and press **Enter**.

Example

The following command associates infeed .aa to UPS record at index number 1:

```
Smart CDU: set ups addinfeed<Enter>
UPS      UPS      Infeed
Index   Type      IDs
1       Liebert
2       MGE      .AA
Select UPS(1-8): 1<Enter>
Infeed ID: .aa<Enter>
```

Removing an infeed from a UPS:

The Set UPS DelInfeed command removes a logical association of an infeed from a UPS.

To remove an infeed from a UPS:

At the Smart CDU: prompt, type **set ups delinfeed** and press **Enter**.

At the prompt, enter the index number for the UPS record to be changed and press **Enter**.

At the prompt, type the absolute infeed ID of the desired infeed, and press **Enter**.

Example

The following command removes the association of infeed .aa from UPS record at index number 2:

```
Smart CDU: set ups delinfeed<Enter>
UPS      UPS      Infeed
Index   Type      IDs
1       Liebert    .AA
2       MGE      .AA
Select UPS(1-8): 2<Enter>
Infeed ID: .aa<Enter>
```

Displaying UPS configuration:

The Show UPS command displays information about all UPS devices.

- UPS Type and Host/IP address
- UPS SNMP port and community string
- SNMP Objects OID values and expected return values

To display UPS configuration information:

At the Smart CDU: prompt, type **show ups** and press **Enter**.

Example

The following command displays UPS configuration information:

```
Smart CDU: show ups<Enter>
 1  Type:      Liebert
    Host/IP:   DC1Liebert1
    Voltage Polling:  ON
    SNMP Configuration
      Community String: public
      SNMP Port:      162
      SNMP Objects/Expected Values
        Voltage:      .1.3.6.1.2.1.33.1.4.4.1.2.1
        Utility Status: .1.3.6.1.2.1.33.1.4.1.0
          On Battery:  0x5
          On Utility:  0x3
More (Y/es N/o):
```

Chapter 4: Advanced Operations

SSL	70
Enabling and Setting up SSL Support	70
SSL Technical Specifications	70
SSH	71
Enabling and Setting up SSH Support	71
SSH Technical Specifications	72
SNMP/THRESHOLDS	73
MIB, OID and Support	73
Enabling and Setting up SNMP Support	73
SNMP Traps	75
Configuring Traps	78
LDAP	81
Enabling and Setting up LDAP Support	82
Configuring LDAP Groups	86
LDAP Technical Specifications	88
TACACS+	89
Enabling and Setting up TACACS+ Support	89
Configuring TACACS+ Privilege Levels	91
TACACS+ Technical Specifications	92
RADIUS	93
Enabling and Setting Up RADIUS Support	93
Vendor-Specific Attributes (VSA):	96
LOGGING	97
Internal System Log	97
Syslog	97
Email	98
UPLOAD/DOWNLOAD	101
Sentry Integrated FTP Server	101
FTP Configuration Files	101
Upload/Download Process	102

SSL

Secure Socket Layers (SSL) version 3 enables secure HTML sessions between a Sentry Remote Power Manager and a remote user. SSL provides two chief features designed to make TCP/IP (Internet) transmitted data more secure:

- Authentication – The connecting client is assured of the identity of the server.
- Encryption – All data transmitted between the client and the server is encrypted rendering any intercepted data unintelligible to any third party.

SSL uses the public-and-private key encryption system by RSA, which also requires the use of digital certificates. An SSL Certificate is an electronic file uniquely identifying individuals or websites and enables encrypted communication; SSL Certificates serve as a kind of digital passport or credential. The Sentry product's SSL Certificate enables the client to verify the Sentry's authenticity and to communicate with the Sentry securely via an encrypted session, protecting confidential information from interception and hacking.

SSL Command Summary

Command	Description
Set SSL	Enables/disables SSL support
Set SSL Access	Sets SSL access as optional or required

Enabling and Setting up SSL Support

NOTE: A restart of the Sentry is required after setting or changing ANY SSL configurations. For more information, see *Performing a warm boot* on page 57.

Enabling or disabling SSL support:

The Set SSL command is used to enable or disable SSL support.

To enable or disable SSL support:

At the Smart CDU: prompt, type **set ssl**, followed by **enabled** or **disabled** and press **Enter**.

Setting SSL access level:

The Set SSL Access command is used to assign use of SSL as optional or required. The default access level is set to optional.

To change the access level:

At the Smart CDU: prompt, type **set ssl access**, followed **optional** or **required**, and press **Enter**.

Example

The following changes the access level to required:

```
Smart CDU: set ssl access required<Enter>
```

SSL Technical Specifications

Secure Socket Layer (SSL) version 3

Transport Layer Security (TLS) version 1 (RFC 2246)

SSL/TLS-enabled HTTPS server (RFC 2818)

Self-Signed X.509 Certificate version 3 (RFC 2459)

Asymmetric Cryptography:

1024-bit RSA Key Exchange

Symmetric Cryptography Ciphers:

TLS_RSA_WITH_AES_256_CBC_SHA

TLS_RSA_WITH_AES_128_CBC_SHA

TLS_RSA_WITH_3DES_EDE_CBC_SHA

TLS_RSA_WITH_DES_CBC_SHA

SSH

Secure Shell (SSH) version 2 enables secure network terminal sessions between a Sentry Remote Power Manager and a remote user over insecure network. SSH provides encrypted terminal sessions with strong authentication of both the server and client, using public-key cryptography and is typically used as a replacement for unencrypted Telnet. In addition to enabling secure network terminal sessions to the Sentry for configuration and power management, the SSH session may be used for secure Pass-Thru connections to attached devices.

SSH requires the configuration and use of a client agent on the client PC. There are many freeware, shareware or for-purchase SSH clients available. Two examples are the freeware client PuTTY and the for-purchase client SecureCRT® by VanDyke® Software. For configuration and use of these clients, please refer to the applicable software documentation.

SSH Command Summary

Command	Description
Set SSH	Enables/disables SSH support
Set SSH AuthMethod	Enables/disables the SSH server authentication methods
Set SSH Port	Sets the SSH server port number

Enabling and Setting up SSH Support

NOTE: A restart of the Sentry is required after setting or changing ANY SSH configurations. For more information, see *Performing a warm boot* on page 57.

Enabling or disabling SSH support:

The Set SSH command is used to enable or disable SSH support.

To enable or disable SSH support:

At the Smart CDU: prompt, type **set ssh**, followed by **enabled** or **disabled** and press **Enter**.

Changing the SSH server port:

With SSH support enabled, the SSH server watches and responds to requests on the default SSH port number 22. This port number may be changed using the Set SSH Port command.

To change the SSH port:

At the Smart CDU: prompt, type **set ssh port**, followed by the port number and press **Enter**.

Example

The following changes the SSH port number to 65535:

```
Smart CDU: set ssh port 65535<Enter>
```

Enabling or disabling SSH server authentication methods:

The Set SSH Authentication Method command is used to set the method of SSH server authentication. The Sentry SSH server supports two authentication methods for security and validation: Password and Keyboard-Interactive.

For information about SSH authentication methods, see *Enabling or Disabling SSH Server Authentication Methods* on page 23.

To enable the SSH authentication methods:

At the Smart CDU: prompt, type **set ssh authmethod**, followed by **password** or **kbint**, followed by **enabled** or **disabled**, and press **Enter**.

Example

The following example sets the SSH authentication method to keyboard-interactive:

```
Smart CDU: set ssh authmethod kbint enabled<Enter>
```

SSH Technical Specifications

Secure Shell (SSH) version 2

Asymmetric Cryptography:

Diffie-Hellman DSA/DSS 512-1024 (random) bits per NIST specification

Symmetric Cryptography:

AES256-CBC	RIJNDAEL256-CBC	3DES-192-CBC
AES192-CBC	RIJNDAEL192-CBC	BLOWFISH-128-CBC
AES128-CBC	RIJNDAEL128-CBC	ARCFOUR-128

Message Integrity:

HMAC-SHA1-160	HMAC-SHA1-96
HMAC-MD5-128	HMAC-MD5-96

Authentication:

Username/Password

Session Channel Break Extension (for RS232 Break)

SNMP/Thresholds

The Sentry family of products supports the Simple Network Management Protocol (SNMP). This allows network management systems to use SNMP requests to retrieve information and control power for the individual outlets.

The Sentry includes an SNMP v2c agent supporting standard MIB I and MIB II objects. A private enterprise MIB extension (Sentry3 MIB) is also supported to provide remote power control.

For information about enabling and configuring SNMP, see *SNMP* on page 32.

NOTE: The default for SNMP support is **Enabled**.

SNMP Command Summary

Command	Description
Set SNMP	Enables or disables SNMP support
Set SNMP Getcomm	Sets the 'get' community string
Set SNMP Setcomm	Sets the 'set' community string
Set SNMP Trapdest	Sets a destination IP address or hostname for traps
Set SNMP Traptime	Sets the delay for steady state condition traps
Set SNMP IPRestrict	Allows SNMP GET and SET requests from defined traps destinations only
Show SNMP	Displays all SNMP configuration information

MIB, OID and Support

The Sentry SNMP MIB and OID are available on the Server Technology website:

<ftp://ftp.servertech.com/pub/SNMP/sentry3>

Technical support is available 8:00AM to 5:00 PM Pacific Time, Monday-Friday.

For SNMP Support, email: mibmaster@servertech.com

Enabling and Setting up SNMP Support

Sentry SNMP support must be enabled and configured for access to Sentry3 MIB objects and generation of all Sentry3 traps.

Enabling/disabling SNMP support:

The Sentry SNMP command is used to enable or disable SNMP support.

To enable SNMP support:

At the Smart CDU: prompt, type **set snmp**, followed by **enabled** or **disabled** and press **Enter**.

NOTE: A restart of the Sentry is required after enabling or disabling SNMP support. For more information, see *Performing a warm boot* on page 57.

Setting trap destinations:

The Set SNMP Trapdest1 and Trapdest2 commands are used to set the IP addresses or hostname of SNMP management stations receiving all traps. Sentry supports a maximum of two trap destinations; one must be defined to enable trap generation.

To set the trap destination:

At the Smart CDU: prompt, type **set snmp, trapdest1** or **trapdest2**, the Ipaddress or hostname and press **Enter**.

Examples

The following sets the trap destination 1 to 64.42.31.208:

```
Smart CDU: set snmp trapdest1 64.42.31.208<Enter>
```

The following sets the trap destination 2 to snmp.servertech.com:

```
Smart CDU: set snmp trapdest2 snmp.servertech.com<Enter>
```

To reset the trap destination:

At the Smart CDU: prompt, type **set snmp, trapdest1** or **trapdest2, 0.0.0.0** and press **Enter**.

Setting the trap timer:

The Set SNMP Traptime command sets the timer period between repeated error-condition traps. The valid range for the timer period is 1 to 65535 (in seconds).

The default value for the timer period is 60 seconds.

To set the trap timer:

At the Smart CDU: prompt, type **set snmp traptime**, followed by the timer period and press **Enter**.

Example

The following sets the timer period to 180 seconds:

```
Smart CDU: set snmp traptime 180<Enter>
```

Setting the Get/Set community strings:

Sentry supports two SNMP community strings that provide varying levels of access to objects defined in the Sentry3 MIB.

Community strings may be 1 to 24 characters.

Setcomm:

The Setcomm string provides read-write access to sentry3 MIB objects.

The default Setcomm string is “private”

To set the Setcomm community string:

At the Smart CDU: prompt, type **set snmp setcomm**, followed by the string and press **Enter**.

Getcomm:

The Getcomm string provides read-only access to sentry3 MIB objects.

The default Getcomm string is “public”.

To set the Getcomm community string:

At the Smart CDU: prompt, type **set snmp getcomm**, followed by the string and press **Enter**.

Setting SNMP IP Restrictions:

The Set SNMP IP Restrictions command supports SNMP Manager GET and SET requests to only be allowed from the IP addresses of the defined traps destinations.

To set SNMP IP Restrictions:

At the Smart CDU: prompt, type **set snmp iprestrict trapdests** and press **Enter**.

To remove SNMP IP Restrictions:

At the Smart CDU: prompt, type **set snmp iprestrict none** and press **Enter**.

Setting the SNMP SysName:

The Set SNMP SysName command is used to set the SNMP MIB-II SysName object.

To set the SysName object:

At the Smart CDU: prompt, type **set snmp sysname**, followed by the object name and press **Enter**.

Setting the SNMP SysLocation:

The Set SNMP SysLocation command is used to set the SNMP MIB-II SysLocation object.

To set the SysLocation object:

At the Smart CDU: prompt, type **set snmp syslocation**, followed by the object location and press **Enter**.

Setting the SNMP SysContact:

The Set SNMP SysContact command is used to set the SNMP MIB-II SysContact object.

To set the SysContact object:

At the Smart CDU: prompt, type **set snmp syscontact**, followed by the object contact and press **Enter**.

Setting the Trap community string:

The Set SNMP Trapcomm command is used to set the community string that is included with all generated traps. This string must be defined to enable trap generation.

The trap community string may be 1 to 24 characters.

The default Trapcomm string is “trap”.

To set the Trapcomm community string:

At the Smart CDU: prompt, type set snmp trapcomm, followed by the string and press Enter.

Displaying SNMP configuration information:

The Show SNMP command displays all SNMP configuration information.

- SNMP support status
- SNMP community strings
- Trap timer value
- Trap destinations

To display SNMP configuration information:

At the Smart CDU: prompt, type **show snmp** and press **Enter**.

Example

The following command displays the SNMP configuration information:

```
Smart CDU: show snmp<Enter>
SNMP Configuration
SNMP:                               Enabled
GET Community String:                public
SET Community String:                private
TRAP Community String:               trap
Error Trap Repeat Time (seconds):    180 seconds
Trap Destination 1:                  64.42.31.208
Trap Destination 2:                  snmp.servertech.com
IP Restrictions:                      Trap Destinations Only
SysName:                              No Name
SysLocation:                          No Location
SysContact:                           No Contact
```

SNMP Traps

The Smart CDU supports four types of SNMP traps. Traps are enabled at the Tower (T), Infeed (I), Environmental Monitor (E) or sensor (S) level.

Trap Summary

Name	Level(s)	Description
Status	T, I, O, E, S	Operational status change
Load	I	Input load out of limit
Temp	S	Temperature is out of range
Humid	S	Relative Humidity is out of range

All traps include the Location of the Sentry as defined with the Set Location command.

Status trap

A Status trap is generated when an error condition occurs on a tower, infeed, Environmental Monitor or individual sensor. Status traps include the reported Status, the Location of the Sentry and identifier and name of the affected tower, infeed, outlet, environmental monitor, or sensor.

Any error state generates a Status trap and triggers the trap timer. A new trap is generated at the end of every timer period until the Status returns to a non-error status. All status traps are enabled by default.

Tower Status traps

Status	Error	Description
Normal		Tower is working correctly
NoComm	x	Communication to the tower has been lost

Infeed Status traps

Status	Error	Description
On		Infeed is on
OffError	x	Infeed should be on but no current is sensed at the infeed
NoComm	x	Communication to the infeed has been lost

Environmental Monitor Status traps

Status	Error	Description
Normal		Environmental Monitor is working correctly
NoComm	x	Communication to the Environmental Monitor has been lost

Temperature/Humidity Sensor Status traps

Status	Error	Description
Found		The sensor has been detected
NotFound		No sensor has been detected
Lost	x	Sensor initially detected but communication to the sensor has been lost
NoComm	x	Communication to the sensor has been lost

NOTE: Traps are generated according to a hierarchical architecture; i.e., if a Tower Status enters a trap condition, only the Tower Status trap will be generated. Infeed, Outlet, Environmental Monitor or Sensor Status and Temp and Humid traps will be suppressed until the Tower Status returns to Normal.

Load Trap

The Load trap is generated whenever the total input load on an infeed exceeds a preset threshold. Load traps include the reported input load, load status, Location of the Sentry, and identifier and name of the affected infeed.

Any error state generates a Load trap and triggers the trap timer. A new trap is generated at the end of every timer period until the Load returns to a non-error status.

Load traps

Status	Error	Description
Normal		Infeed is on and within preset thresholds
NotOn		Infeed is off
Reading		Non-error state – Load status currently being read
LoadHigh	x	Infeed current load exceeds preset threshold
OverLoad	x	Infeed current load exceeds the measurable range for the infeed
ReadError	x	Unable to read Load status
NoComm	x	Communication to the infeed has been lost

Temp Trap

The Temp trap is generated whenever the temperature on a temperature/humidity sensor is beyond preset thresholds. Temp traps include the reported temperature, temp status, Location of the Sentry, and identifier and name of the affected sensor.

Any error state generates a Temp trap and triggers the trap timer. A new trap is generated at the end of every timer period until the Temp returns to a non-error status.

Temp traps

Status	Error	Description
Normal		The sensor is working correctly and the temperature is within preset thresholds
NotFound		No sensor has been detected
Reading		Temp status currently being read
TempLow	x	Temperature at the sensor below preset low threshold
TempHigh	x	Temperature at the sensor exceeds preset high threshold
ReadError	x	Unable to read Temp status
Lost	x	Sensor initially detected but communication to the sensor has been lost
NoComm	x	Communication to the sensor has been lost

Humidity Trap

The Humidity trap is generated whenever the humidity on a temperature/humidity sensor is beyond preset thresholds. Humidity traps include the reported relative humidity, humidity status, Location of the Sentry, and identifier and name of the affected sensor.

Any error state generates a Humidity trap and triggers the trap timer. A new trap is generated at the end of every timer period until the Humidity returns to a non-error status.

Humidity traps

Status	Error	Description
Normal		The sensor is working correctly and the relative humidity is within preset thresholds
NotFound		No sensor has been detected
Reading		Humidity status currently being read
HumidLow	x	Relative humidity at the sensor below preset low threshold
HumidHigh	x	Relative humidity at the sensor exceeds preset high threshold
ReadError	x	Unable to read Humidity status
Lost	x	Sensor initially detected but communication to the sensor has been lost
NoComm	x	Communication to the sensor has been lost

Configuring Traps

SNMP Trap Command Summary

Command	Description
Set Trap Tower Status	Enables or disables the Tower Status trap
Set Trap Infeed Status	Enables or disables the Infeed Status trap off
Set Trap Infeed Load	Enables or disables the Infeed Load trap
Set Trap Infeed HighThresh	Sets the Infeed Load trap high limit
Set Trap EM Status	Enables or disables the Environmental Monitor Status trap
Set Trap THS Status	Enables or disables a temperature/humidity sensor Status trap
Set Trap THS Temp	Enables or disables a temperature/humidity sensor Temp trap
Set Trap THS Temp Delta	Sets temperature recovery delta
Set Trap THS Temphigh	Sets a temperature/humidity sensor Temp trap high limit
Set Trap THS Templow	Sets a temperature/humidity sensor Temp trap low limit
Set Trap THS Humid	Enables or disables a temperature/humidity sensor Humid trap
Set Trap THS Humidhigh	Sets a temperature/humidity sensor Humid trap high limit
Set Trap THS Humidlow	Sets a temperature/humidity sensor Humid trap low limit
Show Traps	Displays trap configurations

Enabling or Disabling a Status trap:

The Set Trap ... Status command is used to enable or disable Status traps for a Tower, Infeed, or Outlet.

To Enable or Disable a Status trap:

At the Smart CDU: prompt, type **set trap (tower, infeed, outlet, em, or ths) status**, followed by the tower, infeed, or outlet name, and **on** or **off**. Press **Enter**, or \

Type **set trap (tower, infeed, outlet, em, or ths) Status all**, followed by **on** or **off** and press **Enter**.

Examples

The following command enables the Status trap for the first tower, using the tower's absolute name:

```
Smart CDU: set trap tower status .a on<Enter>
```

The following command enables the Status trap for the tower named Florida_HQ_1:

```
Smart CDU: set trap tower status Florida_HQ_1 on<Enter>
```

NOTE: Enabling lower hierarchical traps automatically enables traps of higher hierarchical value: i.e. enabling an Outlet Status trap automatically enables the Infeed and Tower Status traps for that outlet. Conversely, if a Tower Status trap is disabled, all associated Infeed Status & Load and Outlet Status traps will be disabled.

Enabling or Disabling a Load trap:

The Set Trap Infeed Load command is used to enable or disable an Infeed Load trap.

To Enable or Disable a Load trap:

At the Smart CDU: prompt, type **set trap infeed load**, followed by the infeed name, and **on** or **off**. Press **Enter**, or

Type **set trap infeed load all**, followed by **on** or **off** and press **Enter**.

Examples

The following command enables the Load trap for second infeed on the first tower, using the infeed's absolute name:

```
Smart CDU: set trap infeed load .AB on<Enter>
```

The following command disables the Load trap for all infeeds:

```
Smart CDU: set trap infeed load all off<Enter>
```

NOTE: Enabling lower hierarchical traps automatically enables traps of higher hierarchical value: i.e. enabling an Infeed Load trap automatically enables the Infeed and Tower Status traps for that infeed.

Setting the Infeed Load limit:

The Set Trap Infeed Loadhigh command is used to set the upper load limits for an input feed.

To set the infeed load limit:

At the Smart CDU: prompt, type **set trap infeed loadhigh**, followed by the infeed name, and a value from 0 to 255 in amperes. Press **Enter**.

Example

The following command sets the infeed load limit for the second infeed on the first tower to 25 amperes, using the absolute name of the infeed:

```
Smart CDU: set trap infeed loadhigh .ab 25<Enter>
```

Enabling or Disabling the Temp trap:

The Set Trap THS Temp command is used to enable or disable the Temp trap.

To Enable or Disable the Temp trap:

At the Smart CDU: prompt, type **set trap ths temp**, followed by the sensor name and **on** or **off**. Press **Enter**.

Example

The following command enables the Temp trap for the first temperature-humidity sensor:

```
Smart CDU: set trap ths temp .a1 on<Enter>
```

Setting the Temperature sensor threshold limits:

The Set Trap THS Templo and Set Trap THS Temphigh commands are used to set the lower and upper threshold limits for the Temperature sensor.

To set the Temperature threshold limits:

At the Smart CDU: prompt, type **set trap ths, templo** or **temphigh**, followed by the sensor name and a value from 0 to 123 degrees Celsius. Press **Enter**.

Example

The following command sets the second temperature high threshold limit to 95:

```
Smart CDU: set trap ths temphigh .a2 95<Enter>
```

Configuring Temperature Recovery Delta:

The Temperature Recovery Delta command allows configuration of the number of degrees of change needed to recover from a temperature alarm. For more information about the recovery delta, see Configuring Temperature Recovery Delta on page 33.

To configure the temperature recovery delta:

At the Smart CDU: prompt, type **set event temp tempdelta**, followed by the sensor name, the number of degrees for the recovery delta, and press **Enter**.

NOTE: The acceptable value range for the Recovery Delta field is 0-10 degrees for Celsius and 0-18 degrees for Fahrenheit. The default value for the Recovery Delta field is 1 degree Celsius and 2 degrees Fahrenheit.

Example

The following command configures the recovery delta at 2 degrees Fahrenheit for temperature/humidity sensor .A1:

```
Smart CDU: event temp tempdelta temp_humid_sensor_A1 2<Enter>
```

Enabling or Disabling the Humid trap:

The Set Trap THS Humid command is used to enable or disable the Humid trap.

To Enable or Disable the Humid trap:

At the Smart CDU: prompt, type **set trap ths humid**, followed by the sensor name and **on** or **off**. Press **Enter**.

Example

The following command enables the Humid trap for the first temperature-humidity sensor:

```
Smart CDU: set traps ths humid .a1 on<Enter>
```

Setting the Humidity sensor threshold limits:

The Set Trap THS Humidlow and Set Trap THS Humidhigh commands are used to set the lower and upper threshold limits for the Humidity sensor.

To set the Humidity threshold limits:

At the Smart CDU: prompt, type **set trap ths, humidlow** or **humidhigh**, followed by the sensor name and a value from 0 to 100 in percent relative humidity. Press **Enter**.

Example

The following command sets the first humidity sensor low threshold limit to 5:

```
Smart CDU: set trap ths humidlow .a1 5<Enter>
```

Displaying trap configuration information:

The Show Traps command displays information about all traps.

To display trap information:

At the Smart CDU: prompt, type **show traps** and press **Enter**.

Example

The following command requests trap configuration information:

```
Smart CDU: show traps <Enter>
Tower trap configuration:
Tower      Tower      Status
ID         Name       Trap
.A         Florida_HQ_1  ON
.B         Florida_HQ_2  ON
More (Y/es N/o): y
Input feed trap configuration:
Input      Input      Status  Load   High
Feed ID   Feed Name  Trap    Trap   Thresh
.AA       HQ_1_Infeed_A  ON      ON     255 A
.BA       HQ_2_Infeed_A  ON      ON     255 A
More (Y/es N/o): y
Environmental Monitor .A trap configuration:
Name: Florida_HQ_1
Status Trap: ON
Temperature/Humidity Sensor .A1      Temperature/Humidity Sensor .A2
Name: Temp_Humid_Sensor_A1          Name: T/H2_Florida_HQ_1
Status Trap: ON                     Status Trap: ON
Temp Trap: ON                       Temp Trap: ON
  Low: 0 Deg.C                      Low: 0 Deg.C
  High: 123 Deg.C                   High: 95 Deg.C
Humid Trap: ON                       Humid Trap: ON
  Low: 5 % RH                       Low: 0 % RH
  High: 100 % RH                    High: 100 % RH
```

LDAP

The Sentry family of products supports Lightweight Directory Access Protocol (LDAP) Version 3. This support enables authentication with LDAP servers; user accounts do not need to be individually created locally on each Sentry device.

This allows administrators to pre-define and configure (in each Sentry product, and in the LDAP server) a set of necessary LDAP Groups, and access rights for each. User's access rights can then be assigned or revoked simply by making the user a member of one-or-more pre-defined Sentry LDAP Groups. User accounts can be added, deleted, or changed in the LDAP server without any changes needed on individual Sentry products.

Sentry LDAP support has been tested in the following environments:

- Microsoft Active Directory (MSAD)
- Novell eDirectory (eDir)
- OpenLDAP

LDAP Command Summary

Command	Description
Set Authorder	Specifies the authentication order for each new session attempt
Set LDAP	Enables/disables LDAP support
Set LDAP Host	Sets the IP address or hostname of the Directory Services server
Set LDAP Port	Sets the LDAP server port number
Set LDAP Bind	Specifies the LDAP bind request password type
Set LDAP BindDN	Specifies the user account Fully-Qualified Distinguished Name (FQDN) for binds
Set LDAP BindPW	Specifies the user account password for binds
Set LDAP GroupAttr	Specifies the user class distinguished name (DN) or names of groups a user is a member of
Set LDAP GroupType	Specifies the data type for the Set LDAP GroupAttr command
Set LDAP UseTLS/SSL	Enables/disables LDAP over TLS/SSL support
Set LDAP UserBaseDN	Sets the base distinguished name (DN) for the username search at login
Set LDAP UserFilter	Sets the filter used for the username search at login
Show LDAP	Displays LDAP configurations
Set DNS	Sets the IP address of the Domain Name System (DNS) server
Ping	Verifies proper DNS configuration by name resolution
Show Network	Displays network configuration information
Create LDAPGroup	Adds an LDAP group name
Remove LDAPGroup	Deletes an LDAP group name
Add PorttoLDAP	Grants an LDAP group access to one or more serial ports
Delete PortfromLDAP	Removes access to one or more serial ports for an LDAP group
Set LDAPGroup Access	Sets the access level for an LDAP group
Set LDAPGroupEnvmon	Grants or removes privileges to view input and environmental monitoring status
List LDAPGroup	Displays all accessible ports for an LDAP group
List LDAPGroups	Displays privilege levels for all LDAP groups

Enabling and Setting up LDAP Support

There are a few configuration requirements for properly enabling and setting up LDAP support. Below is an overview of the minimum requirements.

Directory Services server configuration requirements:

1. Define at least one LDAP group.
2. Assign users to that LDAP group.

Sentry configuration requirements:

1. Enable LDAP support.
2. Define the IP address and domain component of at least one Directory Services server.
3. Set the LDAP bind request method being utilized by the Directory Services server.
4. Define the IP address of at least one DNS server.
5. Test DNS server configuration using Sentry 'ping' support.
6. Define at least one LDAP group and assign access rights for that group.

NOTE: LDAP group names on the Directory Service server and the Sentry must match.

Enabling and disabling LDAP support:

The Set LDAP command is used to enable or disable LDAP support.

To enable or disable LDAP support:

At the Smart CDU: prompt, type **set ldap**, followed by **enabled** or **disabled** and press **Enter**.

Setting the LDAP host address:

The Set LDAP Host command sets the TCP/IP address of the Directory Services server.

To set the LDAP host address:

At the Smart CDU: prompt, type **set ldap**, followed by **host1** or **host2** and the Directory Services server's IP address or hostname. Press **Enter**.

Examples

The following command sets the primary Directory Services server IP address to 98.76.54.32:

```
Smart CDU: set ldap host1 98.76.54.32<Enter>
```

The following command sets the secondary Directory Services server hostname to ldap.servertech.com:

```
Smart CDU: set ldap host2 ldap.servertech.com<Enter>
```

Changing the LDAP server port:

The Set LDAP port command sets the port to which the Sentry sends LDAP requests to on the previously defined LDAP server. The default port is 389.

To change the LDAP server port:

At the Smart CDU: prompt, type **set ldap port**, followed by the port number and press **Enter**.

Example

The following command sets the LDAP server port number to 8888:

```
Smart CDU: set ldap port 8888<Enter>
```

Enabling and disabling LDAP over TLS/SSL support:

The Set LDAP UseTLS command is used to enable or disable LDAP over TLS/SSL support.

To enable or disable LDAP over TLS/SSL support:

At the Smart CDU: prompt, type **set ldap usetls**, followed by **yes** or **no** and press **Enter**.

NOTE: If LDAP over TLS/SSL is enabled, MD5 binding is disabled.

Setting the LDAP bind password type:

The Set LDAP Bind command sets the password type used in the bind requests. The Sentry supports two standard LDAP bind methods: Simple and MD5.

The Simple method uses unencrypted delivery of a username-password over the network to the Active Directory server for authentication.

The MD5 digest method provides much stronger protection using 1-way hash encoding that never transmits the username-password over the network.

NOTE: Windows 2000 supports only Simple binding. Windows 2003 supports both Simple binding and MD5 binding.

To set the bind password type:

At the Smart CDU: prompt, type **set ldap bind**, followed by **simple** or **md5** and press **Enter**.

NOTE: If MD5 binding is enabled, LDAP over TLS/SSL is disabled.

Setting the search bind Distinguished Name (DN):

The Set LDAP BindDN command is used to set the fully-qualified distinguished name (FQDN) for user accounts to bind with. This is required for directory services that do not support anonymous binds. This field is used ONLY with Simple Binds.

Maximum string length is 124 characters.

NOTE: If left blank, then an anonymous bind will be attempted. This field is used ONLY with Simple binds.

To set the search bind DN:

At the Smart CDU: prompt, type **set ldap binddn**, and press **Enter**. At the following prompt, type the FQDN and press **Enter**.

Example

The following sets the FQDN for MSAD to 'cn=guest,cn=Users,dc=servertech,dc=com':

```
Smart CDU: set ldap binddn<Enter>
Enter Search Bind DN (Max characters 124):
cn=guest,cn=Users,dc=servertech,dc=com<Enter>
```

Setting the search bind Distinguished Name (DN) password:

The Set LDAP BindPW command is used to set the password for the user account specified in the Search Bind DN. Maximum password size is 20 characters.

To set the Bind Password DN:

At the Smart CDU: prompt, type **set ldap bindpw** and press **Enter**. At the following prompt, type the bind password and press **Enter**.

Setting the group membership attribute:

The Set LDAP GroupAttr command is used to specify the name of user class attributes that lists distinguished names (DN), or names of groups that a user is a member of. Maximum string length is 30 characters.

To set Group Membership Attribute:

At the Smart CDU: prompt, type **set ldap groupattr** and press **Enter**. At the following prompt, type the group membership attribute and press **Enter**.

Example

The following sets the group membership attribute for MSAD to 'memberof':

```
Smart CDU: set ldap groupattr<Enter>
Enter Group Member Attr (Max character 30):
memberof<Enter>
```

Setting the group membership value type:

The Set LDAP GroupType command is used to specify whether the values of Group Membership Attribute represent the Distinguished Name (DN) of a group or just the name of the group.

To set group membership value type:

At the Smart CDU: prompt, type **set ldap grouptype** followed by **DN** or **Name** and press **Enter**.

Example

The following sets group membership value to DN

```
Smart CDU: set ldap grouptype DN<Enter>
```

Setting the user search base Distinguished Name (DN):

The Set LDAP UserBaseDN command is used to set the base (DN) for the login username search. This is where the search will start, and will include all subtrees. Maximum size is 100 characters.

To set the user search base DN:

At the Smart CDU: prompt, type **set ldap userbasedn** and press **Enter**. At the following prompt, type the search base DN and press **Enter**.

Example

The following sets the DN user search base for MSAD to 'cn=Users,dc=servertech,dc=com':

```
Smart CDU: set ldap userbasedn<Enter>
Enter User Search Base DN (Max characters 100):
cn=Users,dc=servertech,dc=com<Enter>
```

Setting the user search filter:

The Set LDAP UserFilter command is used to set the search filter for the username entered at the login prompt.

The search filter must be entered within parenthesis and adhere to the following format:

(searchfilter=%s)

where 'searchfilter' is the name of the attribute in the user class which has a value that represents the user's login name. In this string, the '%s' will be replaced by the entered username. Maximum string length is 100 characters.

To set the user search filter:

At the Smart CDU: prompt, type **set ldap userfilter** and press **Enter**. At the following prompt, type the User Search Filter and press **Enter**.

Example

The following sets the user search filter for MSAD to 'samaccountname':

```
Smart CDU: set ldap userfilter<Enter>
Enter User Search Filter (Max characters 100):
(samaccountname=%s)<Enter>
```

Setting the authentication order:

The Set Authorder command sets the authentication order for remote authentication sessions. The Sentry supports two methods for authentication order - Remote -> Local and Remote Only.

The Remote -> Local method first attempts authentication with the Active Directory server and if unsuccessful with the local user database on the Sentry device.

The Remote Only method attempts authentication only with the Active Directory server and if unsuccessful, access is denied.

NOTE: With the Remote Only method, if authentication fails due to a communication failure with the Active Directory server automatic authentication fallback will occur to authenticate with the local user data base on the Sentry device.

To set the authentication order:

At the Smart CDU: prompt, type **set authorder**, followed by **remotelocal** or **remoteonly** and press **Enter**.

NOTE: Server Technology recommends **NOT** setting the authentication order to Remote Only until the LDAP has been fully configured and tested.

Displaying LDAP configuration information:

The Show LDAP command displays LDAP configuration information.

- Enabled-disabled status of LDAP support
- Directory Services server IP address and port
- Bind request password type and remote authentication order
- Search bind distinguished name and password
- User search base distinguished name and filter
- Group membership attribute and type

To display the LDAP configuration information:

At the Smart CDU: prompt, type **show ldap** and press **Enter**.

Example

The following command displays the LDAP configuration information:

```
Smart CDU: show ldap
LDAP Configuration
LDAP:          Enabled
Host 1:        98.76.54.32
Host 2:        ldap.servertech.com
Port:          8888
TLS/SSL:       Yes
Bind Type:     MD5
Auth Order:    Remote->Local
Search Bind
  DN: cd=guest,cn=Users,dc=servertech,dc=com
  Password: OpenDoor
User Search
  Base DN: cn=Users,dc=servertech,dc=com
  Filter: (samaccountname=%s)
Group Membership
  Attribute: memberof
  Value Type: DN
```

Setting the DNS IP address:

The Set DNS command sets the TCP/IP address of the Domain Name System (DNS) server.

NOTE: LDAP requires the definition of at least one Domain Name System (DNS) server.

To display the DNS configuration information, use the Show Network command as described on page 58.

To set the DNS IP address:

At the Smart CDU: prompt, type **set**, followed by **dns1** or **dns2** and the Domain Name System (DNS) server's IP address. Press **Enter**.

Example

The following command sets the primary Domain Name System (DNS) server IP address to 98.76.54.254:

```
Smart CDU: set dns1 98.76.54.254<Enter>
```

Verifying the DNS configuration:

The Ping command may be used to verify the configuration of the DNS IP address.

To verify the DNS configuration:

At the Smart CDU: prompt, type **ping**, followed by the domain component of the Directory Services server previously configured and press **Enter**.

Example

The following command verifies the DNS configuration:

```
Smart CDU: ping servertech.com
Pinging servertech.com [98.76.54.32] with 64 bytes of data:
Reply from 98.76.54.32: bytes=64 pseq=0 triptime=0
Reply from 98.76.54.32: bytes=64 pseq=1 triptime=0
Reply from 98.76.54.32: bytes=64 pseq=2 triptime=0
Reply from 98.76.54.32: bytes=64 pseq=3 triptime=0
Reply from 98.76.54.32: bytes=64 pseq=4 triptime=0
```

Configuring LDAP Groups

Creating an LDAP group:

The Create LDAPGroup command creates an LDAP group.

To create an LDAP group:

At the Smart CDU: prompt, type **create ldapgroup**, optionally followed by a 1-16 character group name (Spaces are not allowed, and LDAP group names are not case sensitive). Press **Enter**.

Example

The following command creates the LDAP group PowerUser:

```
Smart CDU: create ldapgroup PowerUser<Enter>
```

Removing an LDAP group:

The Remove LDAPGroup command removes an LDAP group.

To remove an LDAP group:

At the Smart CDU: prompt, type **remove ldapgroup**, optionally followed by a group name. Press **Enter**.

Setting LDAP group access level privileges:

The Set LDAPGroup Access command sets the access level privileges for an LDAP group. The Sentry has four defined access privilege levels; Admin, User, On-Only and View-Only. For more information about user access levels, see Changing a User's Access Privilege Level on page 29.

To set the access level privilege for an LDAP group :

At the Smart CDU: prompt, type **set ldapgroup access**, followed by **admin**, **user**, **ononly** or **viewonly**, optionally followed by a LDAP group name and press **Enter**.

Examples

The following command sets the LDAP group access level for LDAPAdmin to Admin:

```
Smart CDU: set ldapgroup access admin ldapadmin<Enter>
```

The following command sets the LDAP group access level for PowerUser to User:

```
Smart CDU: set ldapgroup access user poweruser<Enter>
```

Granting and removing input status viewing privileges :

The Set LDAPGroup Envmon command grants or removes input status viewing privileges to/from an LDAP group.

To grant or remove input status viewing privileges for an LDAP group:

At the Smart CDU: prompt, type **set ldapgroup envmon** followed by **on** or **off**, optionally followed by a group name and press **Enter**.

Example

The following command grants input status viewing privileges to the LDAP group PowerUser:

```
Smart CDU: set ldapgroup envmon on poweruser<Enter>
```

Displaying the LDAP access privilege levels:

The List LDAPGroups command displays all defined LDAP group with their access privilege level.

To display LDAP group access privilege levels:

At the Smart CDU: prompt, type **list ldapgroups** and press **Enter**.

Example

The following command displays all LDAP groups with their access privilege level:

```
Smart CDU: list ldapgroups<Enter>

LDAP          Access      Environmental
Group Name   Level      Monitoring
LDAPAdmin    Admin      Allowed
PowerUser    User       Allowed
User         On-Only    Not Allowed
Guest        View-Only  Not Allowed
```

Adding serial port access to an LDAP group:

The Add PortToLDAP command grants an LDAP group access to the serial port.

To grant serial port access to an LDAP group:

At the Smart CDU: prompt, type **add porttoldap console** and a group name. Press **Enter**.

Deleting serial port access for an LDAP group:

The Delete PortFromLDAP command removes an LDAP group's access to the serial port. You cannot remove access to the serial port for an administrative level group.

To delete serial port access for a user:

At the Smart CDU: prompt, type **delete portfromldap console** and a group name. Press **Enter**.

Displaying LDAP Group access:

The List LDAPGroup command displays all access rights for an LDAP group.

To display LDAP Group access:

At the Smart CDU: prompt, type **list ldapgroup**, optionally followed by a group name. Press **Enter**.

Example

The following command displays information about the LDAP group PowerUser:

```
Smart CDU: list ldapgroup poweruser<Enter>
Username: PowerUser
Ports:
      Port      Port
      ID        Name
  Console  Console
```

LDAP Technical Specifications

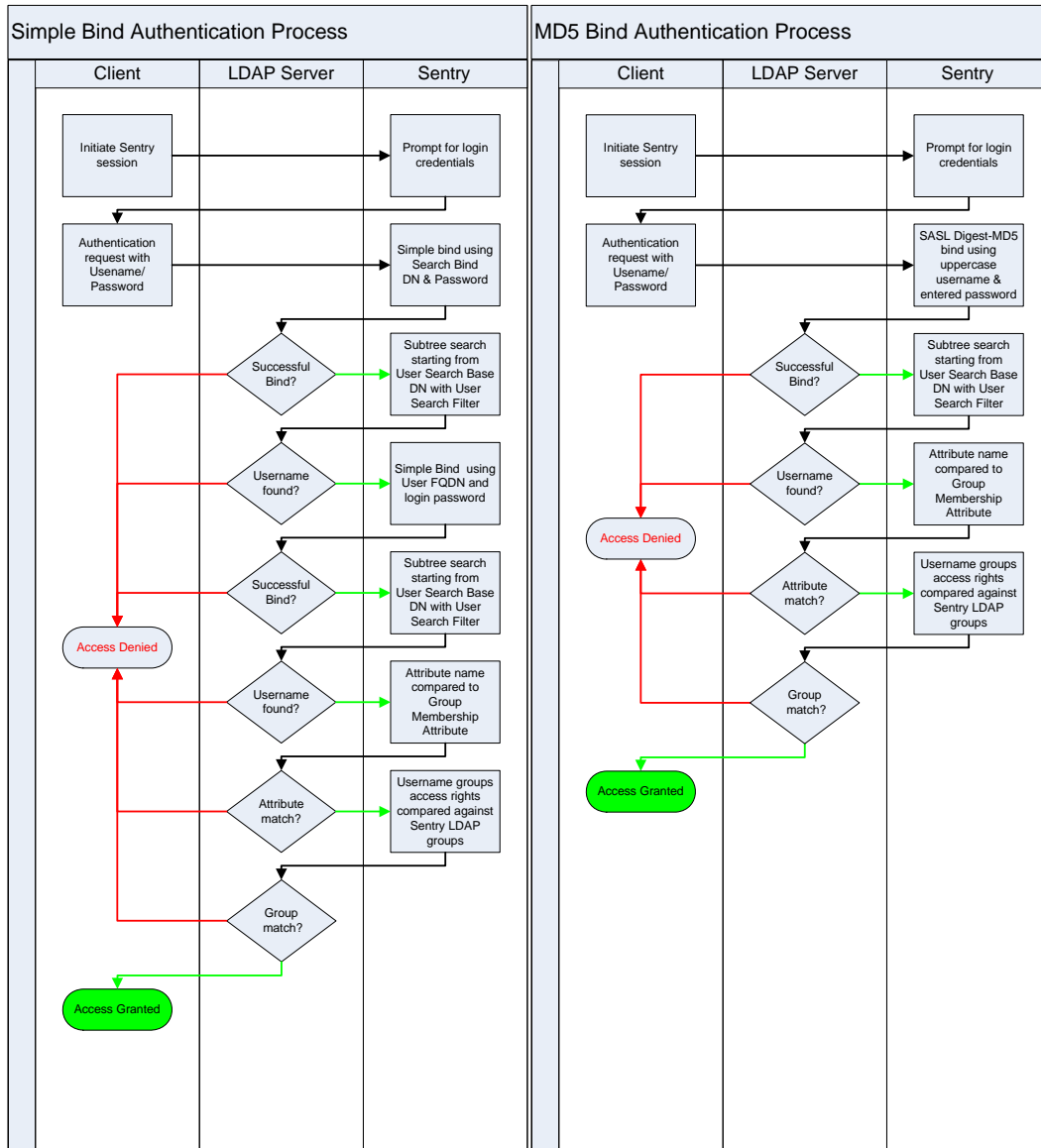

TACACS+

The Sentry family of products supports the Terminal Access Controller Access Control System (TACACS+) protocol. This enables authentication and authorization with a central TACACS+ server; user accounts do not need to be individually created locally on each Sentry device.

This allows administrators to pre-define and configure (in each Sentry product, and in the TACACS+ server) a set of necessary TACACS+ privilege levels, and users' access rights for each. User's access rights can then be assigned or revoked simply by making the user a member of one-or-more pre-defined Sentry TACACS+ privilege levels. User account rights can be added, deleted, or changed within TACACS+ without any changes needed on individual Sentry products.

The Sentry supports 16 different TACACS+ privilege levels; 15 are entirely configurable by the system administrator (1 is reserved for default Admin level access to all Sentry resources).

TACACS+ Command Summary

Command	Description
Set Authorder	Specifies the authentication order for each new session attempt
Set TACACS	Enables/disables TACACS support
Set TACACS Host	Sets the IP address or hostname of the TACACS server
Set TACACS Key	Sets the TACACS encryption key
Set TACACS Port	Sets the TACACS server port number
Show TACACS	Displays TACACS configurations
Add PorttoTACACS	Grants a TACACS account access to one or more serial ports
Delete PortfromTACACS	Removes access to one or more serial ports for a TACACS account
Set TacPriv Access	Sets the access level for a TACACS account
Set TacPriv Envmon	Grants or removes privileges to view input and environmental monitoring status
List TacPrivs	Displays user access levels for all TACACS accounts
List TacPriv	Displays all accessible ports for a TACACS account

Enabling and Setting up TACACS+ Support

There are a few configuration requirements for properly enabling and setting up TACACS+ support. Below is an overview of the minimum requirements:

1. Enable TACACS+ support.
2. Define the IP address and domain component of at least one TACACS+server.
3. Set the TACACS+ key configured on the supporting TACACS+server.

Enabling and disabling TACACS+ support:

The Set TACACS command is used to enable or disable TACACS+ support.

To enable or disable TACACS+ support:

At the Smart CDU: prompt, type **set tacacs**, followed by **enabled** or **disabled** and press **Enter**.

Setting the TACACS+ server address:

The Set TACACS Host command sets the IP address or hostname of the TACACS+ server.

To set the TACACS+ server address:

At the Smart CDU: prompt, type **set tacacs**, followed by **host1** or **host2** and the TACACS+ server's IP address or hostname. Press **Enter**.

Examples

The following command sets the primary TACACS+ server address to 98.76.54.32:

```
Smart CDU: set tacacs host1 98.76.54.32<Enter>
```

The following command sets the secondary TACACS+ server hostname to tacacs.servertech.com:

```
Smart CDU: set tacacs host2 tacacs.servertech.com<Enter>
```

Setting the TACACS+ encryption key:

The Set TACACS Key command sets the encryption key used to encrypt all data packets between the Sentry and the TACACS+ server. This key must match the key configured on the TACACS+ server.

To set the encryption key:

At the Smart CDU: prompt, type **set tacacs key** and press **Enter**.

At the TACACS+ Key: prompt, type an encryption key of up to 60 alphanumeric and other typed characters - (ASCII 33 to 126 decimal) are allowed; encryption keys are case sensitive. Press **Enter**. To specify no password, press **Enter**.

At the Verify TACACS+ Key: prompt, retype the key. Press **Enter**. To verify no password, press **Enter** at the prompt.

Example

```
Smart CDU: set tacacs key<Enter>
TACACS+ Key: <Enter>
Verify TACACS+ Key: <Enter>
```

For security, key characters are not displayed.

NOTE: A key size of zero results in no encryption being applied which may not be supported by the TACACS+ server and is not recommended for a production environment.

Changing the TACACS port:

With TACACS support enabled, the Sentry sends TACACS requests to the default TACACS port number 49. This port number may be changed using the Set TACACS Port command.

To change the TACACS port:

At the Smart CDU: prompt, type **set tacacs port**, followed by the port number and press **Enter**.

Example

The following changes the TACACS port number to 50:

```
Smart CDU: set tacacs port 50<Enter>
```

Setting the authentication order:

The Set Authorder command sets the authentication order for remote authentication sessions. The Sentry supports two methods for authentication order - Remote -> Local and Remote Only.

The Remote -> Local method first attempts authentication with the TACACS+ server and if unsuccessful with the local user database on the Sentry device.

The Remote Only method attempts authentication only with the TACACS+ server and if unsuccessful, access is denied.

NOTE: With the Remote Only method, if authentication fails due to a communication failure with the TACACS+ server automatic authentication fallback will occur to authenticate with the local user data base on the Sentry device.

To set the authentication order:

At the Smart CDU: prompt, type **set authorder**, followed by **remotelocal** or **remoteonly** and press **Enter**.

NOTE: Server Technology recommends NOT setting the authentication order to Remote Only until the TACACS+ has been fully configured and tested.

Displaying TACACS+ configuration information:

The Show TACACS command displays TACACS+ configuration information.

To display the TACACS configuration information:

At the Smart CDU: prompt, type **show tacacs** and press **Enter**.

Example

The following command displays the TACACS configuration information:

```
Smart CDU: show tacacs<Enter>
TACACS+ Configuration
TACACS+:      Enabled
Host 1:       98.76.54.32
Host 2:       tacacs.servertech.com
Port:         50
TACACS+ Key:  (Set)
Auth Order:   Remote->Local
```

Configuring TACACS+ Privilege Levels

Setting TACACS+ account access level privileges:

The Set TacPriv Access command sets the access level privileges for a TACACS+ account. The Sentry has four defined access privilege levels; Admin, User, On-Only and View-Only. For more information about user access levels, see Changing a User's Access Privilege Level on page 29.

To set the access level privilege for a TACACS+ account :

At the Smart CDU: prompt, type **set tacpriv access**, followed by **admin**, **user**, **ononly** or **viewonly**, optionally followed by a TACACS+ account number and press **Enter**.

Examples

The following command sets the TACACS+ account access level for account 14 to Admin:

```
Smart CDU: set tacpriv access admin 14<Enter>
```

The following command sets the TACACS+ account access level for account 5 to User:

```
Smart CDU: set tacpriv access user 5<Enter>
```

Granting and removing input status viewing privileges:

The Set TacPriv Envmon command grants or removes input status viewing privileges to/from a TACACS+ account.

To grant or remove input status viewing privileges for a TACACS+ account:

At the Smart CDU: prompt, type **set tacpriv envmon**, followed by **on** or **off**, optionally followed by a TACACS+ account number and press **Enter**.

Example

The following command grants input status viewing privileges to the TACACS+ account 5:

```
Smart CDU: set tacpriv envmon on 5<Enter>
```

Displaying the TACACS+ access privilege levels:

The List TacPrivs command displays all TACACS+ accounts with their access privilege levels.

To display TACACS+ account access privilege levels:

At the Smart CDU: prompt, type **list tacprivs** and press **Enter**.

Example

The following command displays all TACACS+ account with their access privilege level:

```
Smart CDU: list tacprivs<Enter>
TACACS      Access      Environmental
Account Name Level          Monitoring
TACAdmin    Admin          Allowed
PowerUser   User           Allowed
User        On-Only       Not Allowed
Guest       View-Only     Not Allowed
```

Adding serial port access to a TACACS+ account:

The Add PortToTACACS command grants a TACACS+ account access to the serial port.

To grant serial port access to a TACACS+ account:

At the Smart CDU: prompt, type **add porttotacacs console** and a TACACS+ account number. Press **Enter**.

Deleting serial port access for a TACACS+ account:

The Delete PortFromTACACS command removes a TACACS+ account's access to the serial port. You cannot remove access to the serial port for an administrative level account.

To delete serial port access for a TACACS+ account:

At the Smart CDU: prompt, type **delete portfromtacacs console** and a TACACS+ account number. Press **Enter**.

Displaying TACACS account access:

The List TacPriv command displays all access rights for a TACACS+ account.

To display TACACS account access:

At the Smart CDU: prompt, type **list tacpriv**, optionally followed by a TACACS+ account. Press **Enter**.

Example

The following command displays information about the TACACS+ account 1:

```
Smart CDU: list tacpriv 1<Enter>
TACACS+ Privilege Level: 1
Ports:
  Port ID  Port Name
  Console  Console
```

TACACS+ Technical Specifications

Authentication START Packet includes:

```
action = 1 (TAC_PLUS_AUTHEN_LOGIN)
priv_lvl = 0 (TAC_PLUS_PRIV_LVL_MIN)
authen_type = 1 (TAC_PLUS_AUTHEN_TYPE_ASCII)
service = 1 (TAC_PLUS_AUTHEN_SVC_LOGIN)
user = (entered username)
port = (access path into the Sentry)
rem_addr = 'Sentry3_XXXXXX' (XXXXXX is last six digits of MAC address)
data = "" (null)
```

NOTE: The password is sent in a CONTINUE packet.

Authorization REQUEST Packet includes:

```
authen_method = 6 (TAC_PLUS_AUTHEN_METH_TACACSPLUS)
priv_lvl = 0 (TAC_PLUS_PRIV_LVL_MIN)
authen_type = 1 (TAC_PLUS_AUTHEN_TYPE_ASCII)
authen_service = 1 (TAC_PLUS_AUTHEN_SVC_LOGIN)
user = (entered username)
port = (access path into the Sentry)
rem_addr = 'Sentry3_XXXXXX' (XXXXXX is last six digits of Ethernet MAC address)
service = 'shell' (for exec)
cmd = "" (null)
```

NOTE: The access paths into the Sentry which support TACACS+ are 'Console', 'Telnet', 'SSH', 'HTTP' and 'HTTPS'. In the case of 'Console' and 'Modem', an administrator is allowed to rename these ports in which case the assigned name is used.

RADIUS

The Sentry family of products supports the Remote Authentication Dial-in User Service (RADIUS) protocol. RADIUS provides a centralized network protocol to enable remote authentication and authorization, such as user names and passwords. With a central RADIUS server, user accounts do not need to be individually created locally on each Sentry device. This allows administrators to pre-define and configure (in each Sentry product and in the RADIUS server), a set of necessary RADIUS privilege levels and user access rights for each level.

RADIUS is also used in enterprise-wide networks because it provides the administrator with high performance, less memory usage, less CPU cycles on routers and switches, and an open standard that is easily interoperable within the network.

In addition to the protocol-required attributes, the RADIUS authentication process can be extended by using private vendor-specific attributes (VSA). This extension allows Server Technology to create its own proprietary attributes to support features and services using the Sentry CDU in the RADIUS authentication process.

RADIUS Command Summary

Command	Description
Set Authorder	Specifies the authentication order for each new session attempt
Set RADIUS	Enables or disables RADIUS support
Set RADIUS ... Server	Configures the address of the RADIUS server
Set RADIUS ... Secret	Sets the shared secret for the RADIUS server
Set RADIUS ... Port	Sets the port number of the RADIUS server
Set RADIUS ... Timeout	Configures the timeout interval for the RADIUS server
Set RADIUS ... Retries	Sets the number of retries for the RADIUS server
Show RADIUS	Displays RADIUS configuration settings

Enabling and Setting Up RADIUS Support

The following configuration tasks are required to properly enable and set up RADIUS support on the primary and secondary RADIUS servers.

Enabling and disabling RADIUS support:

The Set RADIUS command enables or disables RADIUS support.

To enable or disable RADIUS support:

At the Smart CDU: prompt, type **set radius**, followed by **enabled** or **disabled**, and press **Enter**.

Setting the authentication order:

The Set Authorder command sets the authentication order for remote authentication sessions. The Sentry supports two methods for authentication order: Remote -> Local and Remote Only.

The Remote -> Local method first attempts authentication with the RADIUS server, and, if unsuccessful, then attempts authentication with the local user database on the Sentry device.

The Remote Only method attempts authentication only with the RADIUS server, and, if unsuccessful, access is denied.

NOTE: With the Remote Only method, if authentication fails due to a communication failure with the RADIUS server automatic authentication fallback will occur to authenticate with the local user data base on the Sentry device.

To set the authentication order:

At the Smart CDU: prompt, type **set authorder**, followed by **remotelocal** or **remoteonly** and press **Enter**.

NOTE: Server Technology recommends NOT setting the authentication order to Remote Only until the RADIUS has been fully configured and tested.

Setting the RADIUS server address:

The Set RADIUS Server command sets the IP address or hostname of the primary or secondary server used for RADIUS authentication requests.

To set the RADIUS server address:

At the Smart CDU: prompt, type **set radius**, followed by **primary** or **secondary**, followed by **server**, and the RADIUS server's IP address or hostname (maximum 63 characters). Press **Enter**.

Examples

The following command sets the primary RADIUS server address to 98.76.54.32:

```
Smart CDU: set radius primary server 98.76.54.32<Enter>
```

The following command sets the secondary RADIUS server address to radius.servertech.com:

```
Smart CDU: set radius secondary server radius.servertech.com<Enter>
```

Setting the RADIUS secret:

The Set RADIUS Secret command sets the shared secret for the server used for RADIUS authentication requests.

To set the shared secret:

At the Smart CDU: prompt, type **set radius**, followed by **primary** or **secondary**, and followed by **secret**. Press **Enter**.

Enter the shared secret and press **Enter**. For security, shared secret characters are not displayed.

Changing the RADIUS port number:

The Set RADIUS Port command sets the server port number for RADIUS authentication requests.

To change the port number:

At the Smart CDU: prompt, type **set radius**, followed by **primary** or **secondary**, followed by **port**, and the port number (1-65535). Press **Enter**.

The default is 1812.

Example

The following command sets the secondary RADIUS server port number to 1855:

```
Smart CDU: set radius secondary port 1855<Enter>
```

Setting the RADIUS timeout value:

The Set RADIUS Timeout command sets the time interval to wait for a reply from the RADIUS server before resending the authentication request.

To set the timeout value:

At the Smart CDU: prompt, type **set radius**, followed by **primary** or **secondary**, followed by **timeout**, and the time interval in seconds (1-30). Press **Enter**.

Examples

The following command sets the primary RADIUS server timeout value to 15 seconds:

```
Smart CDU: set radius primary timeout 15<Enter>
```

The following command sets the secondary RADIUS server timeout value to 5 seconds:

```
Smart CDU: set radius secondary timeout 5<Enter>
```

Setting the number of RADIUS server retries:

The Set RADIUS Retries command specifies the number of times an authentication request is sent to the RADIUS server. The Sentry will attempt authentication with the primary server until the number of retries is reached, then will attempt authentication with the secondary server. If the Sentry does not receive a response from these attempts, the authentication request will be rejected.

To set the number of retries:

At the Smart CDU: prompt, type **set radius**, followed by **primary** or **secondary**, followed by **retries**, and followed by the number of retries (0-10). Press **Enter**.

Examples

The following command sets the retries for the primary RADIUS server to 5:

```
Smart CDU: set radius primary retries 5<Enter>
```

The following command sets the retries for the secondary RADIUS server to 2:

```
Smart CDU: set radius secondary retries 2<Enter>
```

Displaying RADIUS configuration information:

The Show RADIUS command displays RADIUS configuration information.

To display the RADIUS configuration information:

At the Smart CDU: prompt, type **show radius** and press **Enter**.

Example

The following command displays the RADIUS configuration information:

```
Smart CDU: show radius<Enter>
RADIUS Configuration

RADIUS:           Enabled
Auth Order:       Remote->Local
Primary Server:
  Shared Secret:  ****
  Port:           1812
  Timeout:        15 seconds
  Retries:        5
Secondary Server:
  Shared Secret:
  Port:           1855
  Timeout:        5 seconds
  Retries:        2
```

Vendor-Specific Attributes (VSA):

Server Technology has defined and formatted RADIUS vendor-specific attributes (VSA) in the **dictionary.sti** file, which is available from Server Technology. The Sentry device is configured to recognize and use the configuration values in the file as specified by the network administrator, indicating to the RADIUS server that the defined attributes are based on Server Technology's unique enterprise vendor code.

Using the format of the **dictionary.sti** file (located on the Server Technology FTP site at <ftp.serverstech.com>), the Sentry RADIUS implementation supports the following vendor-specific attributes:

Vendor-Specific Attribute (VSA) Descriptions

Attribute	Description
STI-Access-Level	Indicates user access level for the Smart POPS CDU; values are 1-6 as follows; a valid access level is required or access to the CDU is denied. Valid User Access Levels: 1 = Admin 2 = Power User 3 = User 4 = Reboot Only 5 = On Only 6 = View Only
STI-Env-Mon	Determines user access rights to environmental monitoring; values are Yes or No. For the STI-Access-Level value other than 1 (Admin), if STI-Env-Mon is not included for a user, default is no.
STI-Ports	Specifies user access rights to ports; values are space-delimited strings of absolute IDs, names, or the special keyword "ALL". String values are case-sensitive and limited to 253 characters. This attribute can be repeated to append strings that declare additional access rights. For STI-Access Level values other than 1 (Admin) and 2 (Power User), if STI-Ports is not included for a user, the default is no ports.

NOTE: User access levels must be configured using the **dictionary.sti** file. If the administrator does not use the **dictionary.sti** file to configure a user, the user will not have access rights to the Sentry CDU.

Examples:

Administrator with full access and configuration rights:

```
sti-admin Auth-Type := Local, User-Password == "admin"  
STI-Access-Level = Admin
```

Power user with environmental monitoring allowed and full port access rights:

```
sti-power Auth-Type := Local, User-Password == "power"  
STI-Access-Level = Power-User,  
STI-Env-Mon = Yes
```

User with environmental monitoring not allowed and specific port access rights:

```
sti-user Auth-Type := Local, User-Password == "user"  
STI-Access-Level = User,  
STI-Env-Mon = No,  
STI-Outlets = ".A1 .A2 Rtr1 Rtr2 Srvr1 Srvr2",  
STI-Outlets += ".A3 .A4 Rtr3 Rtr4 Srvr3 Srvr4",  
STI-Groups = "Routers Servers",  
STI-Ports = "Console"
```

View-only user with environmental monitoring allowed and access rights:

```
sti-view Auth-Type := Local, User-Password == "view"  
STI-Access-Level = View-Only,  
STI-Env-Mon = Yes
```

Logging

The Sentry family of products supports logging of system events both internally and externally. An internal log of more than 4000 events is automatically maintained and is reviewable by administrative users. For permanent/long-term log storage, Sentry supports the Syslog protocol. And for immediate notification, Sentry supports Email notifications.

Log entries include a sequential entry number, a date/time stamp and an event message. The event message is preceded with a message 'type' heading and if the event is tied to a user, the username will be included.

NOTE: For date/time stamp support, SNTP server support must be configured. For more information SNTP, see page 31.

The Sentry supports the following event message headers:

- AUTH: All authentication attempts.
- POWER: All power state change requests.
- CONFIG: All system configuration changes.
- EVENT: All general system events. Example: over/under threshold event.

Internal System Log

The internal system log is stored in the local memory and has support for up to 4097 continuously aging entries. The internal system log is only available to administrative users. For instructions on reviewing the internal log, see page 40.

Syslog

The Sentry's Syslog support is RFC3164-compliant and enables off-Sentry viewing and storage of log messages. The Sentry supports external logging to up to two Syslog servers.

Syslog Command Summary

Command	Description
Set Syslog HostIP	Sets the IP address of the Syslog server
Set Syslog Port	Sets the Syslog server port number
Show Syslog	Displays all Syslog configuration information

Setting the Syslog server IP address:

The Set Syslog HostIP command sets the TCP/IP address of the Syslog server.

To set the Syslog server IP address:

At the Smart CDU: prompt, type **set syslog**, followed by **hostip1** or **hostip2** and the Syslog server's IP address. Press **Enter**.

Example

The following command sets the primary Syslog server IP address to 56.47.38.29:

```
Smart CDU: set syslog hostip1 56.47.38.29<Enter>
```

Changing the Syslog server port:

With Syslog support enabled, the Syslog server watches and responds to requests on the default Syslog port number 514. This port number may be changed using the Set Syslog Port command.

To change the Syslog port:

At the Smart CDU: prompt, type **set syslog port**, followed by the port number and press **Enter**.

Example

The following changes the Syslog port number to 411:

```
Smart CDU: set syslog port 411<Enter>
```

Displaying Syslog configuration information:

The Show Syslog command displays Syslog configuration information.

To display the Syslog configuration information:

At the Smart CDU: prompt, type **show syslog** and press **Enter**.

Example

The following command displays the Syslog configuration information:

```
Smart CDU: show syslog<Enter>
SYSLOG Configuration
  Primary Syslog Server IP Address:    56.47.38.29
  Secondary Syslog Server IP Address:  0.0.0.0
  Syslog Server Port:                  411
```

Email

Email Command Summary

Command	Description
Set Email	Enables or disables Email notification support
Set Email SMTP Host	Sets the SMTP Host IP address or hostname
Set Email SMTP Port	Sets the SMTP server port number
Set Email From	Sets the email 'From' address
Set Email PrimaryTo	Sets the primary recipient email address
Set Email SecondaryTo	Sets the secondary recipient email address
Set Email Event	Enables or disables notification of general system events
Set Email Auth	Enables or disables notification of all authentication attempts
Set Email Power	Enables or disables notification of power state change requests
Set Email Config	Enables or disables notification of configuration changes
Show Email	Displays all Email configuration information

Enabling or disabling Email notification Support:

The Set Email command enables or disables Email notification support.

To enable or disable Email notification support:

At the Smart CDU: prompt, type **set email**, followed by **enabled** or **disabled** and press **Enter**.

Setting the SMTP server address:

The Set Email Host command sets the IP address or hostname of the SMTP server.

To set the SMTP server address:

At the Smart CDU: prompt, type **set email smtp host**, followed by the SMTP server's IP address or hostname and press **Enter**.

Examples

The following command sets the SMTP server address to 55.55.55.55:

```
Smart CDU: set email smtp 55.55.55.55<Enter>
```

The following command sets the SMTP server address to email.servertech.com:

```
Smart CDU: set email smtp email.servertech.com<Enter>
```

Changing the SMTP server port:

With SMTP support enabled, the Sentry sends SMTP requests to the default SMTP port number 25. This port number may be changed using the Set Email SMTP Port command.

To change the TACACS port:

At the Smart CDU: prompt, type **set email smtp port**, followed by the port number and press **Enter**.

Example

The following changes the SMTP port number to 5555:

```
Smart CDU: set email smtp port 5555<Enter>
```

Setting the 'From' email address:

The Set Email From command sets the 'from' email address. By default, this is set to 'Sentry3_' plus the last three octets of the unit's MAC address. Example: 'Sentry3_510c90@'

To set the 'From' email address:

At the Smart CDU: prompt, type **set email from**, followed by the originating email address and press **Enter**.

Example

The following command sets the 'from' email address to Rack14CDU1@servertech.com:

```
Smart CDU: set email from Rack14CDU1@servertech.com<Enter>
```

Setting the 'To' email address:

The Set Email PrimaryTo and Set Email SecondaryTo commands set the recipient email addresses.

To set the 'To' email address:

At the Smart CDU: prompt, type **set email**, followed by **primaryto** or **secondaryto** and the destination email address. Press **Enter**.

Examples

The following command sets the primary 'to' email address to DayAdmin@servertech.com:

```
Smart CDU: set email primaryto DayAdmin@servertech.com<Enter>
```

The following command sets the secondary 'to' email address to NiteAdmin@servertech.com:

```
Smart CDU: set email secondaryto NiteAdmin@servertech.com<Enter>
```

Enabling or disabling event notification types:

The Set Email Event, Set Email Auth, Set Email Power and Set Email Config commands enable or disable email notification of the event types as described on page 93.

To enable or disable event notification types:

At the Smart CDU: prompt, type **set email**, followed by **event**, **auth**, **power** or **config** and **enabled** or **disabled**. Press **Enter**.

Examples

The following command sets the enables email notification general system events:

```
Smart CDU: set email event enabled<Enter>
```

The following command sets the disables email notification authentications attempts:

```
Smart CDU: set email auth disable<Enter>
```

Displaying Email configuration information:

The Show Email command displays Email configuration information.

To display the Email configuration information:

At the Smart CDU: prompt, type **show email** and press **Enter**.

Example

The following command displays the Email configuration information:

```
Smart CDU: show email
  Email Configuration
    Email Notifications:      Enabled
    SMTP Host:                email.servertech.com
    SMTP Port:                5555
    'From' Address:           Rack14CDU1@servertech.com
    Primary 'Send To' Address: DayAdmin@servertech.com
    Secondary 'Send To' Address: NiteAdmin@servertech.com
    Include EVENT Messages:   Enabled
    Include AUTH Messages:    Disabled
    Include POWER Messages:   Disabled
    Include CONFIG Messages:  Disabled
```

Upload/Download

The Sentry family of product supports the ability to upload and download system configurations using a standard FTP client. This feature enables for backup and restoration of system configuration as well as upload of 'template' configurations to ease large initial equipment deployments.

Upload/Download Command Summary

Command	Description
Set FTP Server	Enables or disables the FTP server
Show FTP	Displays FTP configuration information

Sentry Integrated FTP Server

The Sentry supports an integrated FTP Server which must be enabled for Upload/Download support. The Sentry FTP Server supports a single user at a time. Once an administrative user has authenticated with the Sentry FTP Server, standard FTP client commands may be used to upload or download Sentry configurations.

NOTE: The integrated FTP Server does NOT support web browser FTP file transfers. A non-web-browser is required for all Upload/Download requests.

Enabling and disabling the FTP server:

The Set FTP Server command is used to enable or disable the integrated FTP server.

To enable or disable the FTP server:

At the Smart CDU: prompt, type **set ftp server**, followed by **enabled** or **disabled** and press **Enter**.

FTP Configuration Files

The Sentry FTP server supports upload/download of two configuration files: CONFIG.BIN and NETWORK.INI. These files may be uploaded or downloaded using FTP PUT and GET operations.

- **CONFIG.BIN** This file contains the entire configuration of the Sentry excluding TCP/IP settings, serial/factory-only configurations, the x.509 certificate (SSL) and SSH keys. This file is encoded to keep all data (including usernames, passwords etc.) out of plain view. **This file is NOT editable.**
- **FTP.INI** This file contains only the FTP settings (FTP Host, username, password, filepath, filename and automatic updates support). This file is user readable and editable 'plain text' file.
- **NETWORK.INI** This file contains only the TCP/IP settings (IP address, subnet mask, gateway, DNS1 and DNS2). This file is user readable and editable 'plain text' file.
- **SNTP.INI** This file contains only the SNTP settings (SNTP Hosts and GMT offset). This file is user readable and editable 'plain text' file.

NOTE: The CONFIG.BIN file while *encoded* is not encrypted and susceptible to decoding using simple tools. Server Technology recommends the secure storage of CONFIG.BIN backup images.

Upload/Download Process

GETting a configuration file (Download):

1. Open the FTP client.
*In a Windows environment, in the Run window type **ftp** and press **Enter**.*
2. At the prompt, type **open**, followed by the IP address of the Sentry and press **Enter**.
FTP> open 12.34.56.78<Enter>
3. Authenticate with the appropriate administrative username and password.
4. At the prompt, type **get**, followed by the filename and press **Enter**.
FTP> get config.bin<Enter>
5. At the prompt, type **close** to close the connection to the Sentry.
FTP> close

PUTting a configuration file (Upload):

NOTE: Uploading the CONFIG.BIN file takes considerably longer than the NETWORK.INI file. When uploading both, Server Technology recommends uploading the NETWORK.INI file first.

1. Open the FTP client.
*In a Windows environment, in the Run window type **ftp** and press **Enter**.*
2. At the prompt, type **open**, followed by the IP address of the Sentry and press **Enter**.
FTP> open 12.34.56.78<Enter>
3. Authenticate with the appropriate administrative username and password.
4. At the prompt, type **put**, followed by the filename and press **Enter**.
FTP> put network.ini<Enter>
5. At the prompt, type **close** to close the connection to the Sentry and force a restart of the device.
FTP> close

Appendix A: Resetting to Factory Defaults

You can reset the non-volatile RAM that stores all configurable options. This clears all administrator-editable fields and resets all command line configurable options to their default values, including all user accounts.

You can also reset the unit to factory defaults from the command line or the Web interface, or by pressing the Reset button. You must have administrator-level privileges to issue the command. Using the reset button may be necessary when a forgotten password prevents administrator login. Each of the methods updates the current working configuration to the factory defaults.

NOTE: Resetting the unit resets all TCP/IP and Telnet/Web configurations. Reconfiguring the TCP/IP and Telnet/web settings will be required.

To reset to factory defaults from the Web interface

On the Restart page in the Tools section of the Web interface, select **Restart and reset to factory defaults** from the drop-down menu and press **Apply**.

To reset to factory defaults from the command line

At the Smart CDU: prompt, type **restart factory** and press **Enter**.

To reset to factory defaults using the reset button

Locate the recessed reset button directly beside the Serial & Ethernet ports. You will need a non-conductive, non-metallic tool that fits inside the recess.

NOTE: This method will NOT work if the reset button has been disabled by the administrator.

Insert the tool in the recess, then depress and hold the reset button for at least ten seconds.

NOTE: If the reset button is depressed and held for more than 15 seconds, the reset will abort.

Appendix B: Uploading Firmware

You may upload new versions of firmware using File Transfer Protocol (FTP). This allows access to new firmware releases for firmware improvements and new features additions.

NOTE: To begin an FTP upload session, you must first configure the FTP Host address, username/password, filename and filepath. For information about configuring the FTP settings required for firmware uploads, see Chapter 3: Operations on page 11.

You may initiate an FTP upload session by issuing a command or from the Web interface. You must have administrator-level privileges to initiate an upload.

To initiate an FTP upload session from the Web interface

On the Restart page in the Tools section of the Web interface, select **Restart and upload firmware via FTP** from the drop-down menu and press **Apply**.

Upon issuing this command the unit will restart and upload the firmware file specified with the FTP Filename command from the previously configured FTP Host.

To initiate an FTP upload session from the command line

The Restart FTPLoad command initiates an upload of firmware. Upon issuing this command the unit will restart and upload the firmware file specified with the FTP Filename command from the previously configured FTP Host.

To initiate an FTP firmware upload session:

At the Smart CDU: prompt, type **restart ftpload** and press **Enter**.

Appendix C: Technical Specifications

Domestic Models

Smart POPS CDU

Model	Rated Voltage	Input Cordset and Plug (10')	Outlets
CSG-24V2A415A1	208-240V 50/60Hz	IEC 60320 C20*	18/6 ²
CSG-24V2C415A1	208-240V 50/60Hz	NEMA L6-30P, 30A/208V locking	18/6 ²
CSG-24VDD415A1	3/PE 240V 50/60Hz	NEMA L15-20P, 20A/240V locking	18/6 ²
CSG-24VDE415A1	3/PE 240V 50/60Hz	NEMA L15-30P, 30A/240V locking	18/6 ²
CSG-24VYL1415A1	3/N/PE 208V 50/60Hz	NEMA L21-20P, 20A/208V locking	18/6 ²
CSG-24VYM411A1	3/N/PE 208V 50/60Hz	NEMA L21-30P, 30A/208V locking	18/6 ²
CSG-24VDX415A9	3/PE 240V 50/60Hz	IEC 60309, 60A 4-Pin 9Hr Blue	12/12 ²
CSG-24VDV415A9	3/PE 240V 50/60Hz	CS8365C, 50A/240V locking	12/12 ²
CSG-24VYY411A9	3/N/PE 208V 50/60Hz	IEC 60309, 60A 5-Pin 9Hr Blue	12/12 ²
CSG-24V53421A9	3/N/PE 415V 50/60Hz	IEC 60309, 20A 5-Pin 6Hr Red	12/12 ²
CSG-24V54421A9	3/N/PE 415V 50/60Hz	IEC 60309, 30A 5-Pin 6Hr Red	12/12 ²
CSG-24V5Z421A9	3/N/PE 415V 50/60Hz	NEMA L22-30P 30A/480V locking	12/12 ²

Smart POPS Expansion Module CDU

Model	Rated Voltage	Input Cordset and Plug (10')	Outlets
CLG-24V2A415A1	208-240V 50/60Hz	IEC 60320 C20*	18/6 ²
CLG-24V2C415A1	208-240V 50/60Hz	NEMA L6-30P, 30A/208V locking	18/6 ²
CLG-24VDD415A1	3/PE 240V 50/60Hz	NEMA L15-20P, 20A/240V locking	18/6 ²
CLG-24VDE415A1	3/PE 240V 50/60Hz	NEMA L15-30P, 30A/240V locking	18/6 ²
CLG-24VYL415A1	3/N/PE 208V 50/60Hz	NEMA L21-20P, 20A/208V locking	18/6 ²
CLG-24VYM411A1	3/N/PE 208V 50/60Hz	NEMA L21-30P, 30A/208V locking	18/6 ²
CLG-24VDX415A9	3/PE 240V 50/60Hz	IEC 60309, 60A 4-Pin 9Hr Blue	12/12 ²
CLG-24VDV415A9	3/PE 240V 50/60Hz	CS8365C, 50A/240V locking	12/12 ²
CLG-24VYY411A9	3/N/PE 208V 50/60Hz	IEC 60309, 60A 5-Pin 9Hr Blue	12/12 ²
CLG-24V53421A9	3/N/PE 415V 50/60Hz	IEC 60309, 20A 5-Pin 6Hr Red	12/12 ²
CLG-24V54421A9	3/N/PE 415V 50/60Hz	IEC 60309, 30A 5-Pin 6Hr Red	12/12 ²
CLG-24V5Z421A9	3/N/PE 415V 50/60Hz	NEMA L22-30P 30A/480V locking	12/12 ²

International Models

Smart POPS CDU

Model	Rated Voltage	Input Cordset and Plug (10')	Outlets
CSG-24VEA415A1	230V 50/60Hz	IEC 60320 C20 ¹	18/6 ²
CSG-24VEK415A1	230V 50/60Hz	IEC 60309, 32A 3-Pin 6Hr Blue	18/6 ²
CSG-24V4J421A9	3/N/PE 400V 50/60Hz	IEC 60309, 16A 5-Pin 6Hr Red	12/12 ²
CSG-24V4K425A9	3/N/PE 400V 50/60Hz	IEC 60309, 32A 5-Pin 6Hr Red	12/12 ²

Smart POPS Expansion Module CDU

Model	Rated Voltage	Input Cordset and Plug (10')	Outlets
CLG-24VEA415A1	230V 50/60Hz	IEC 60320 C20 ¹	18/6 ²
CLG-24VEK415A1	230V 50/60Hz	IEC 60309, 32A 3-Pin 6Hr Blue	18/6 ²
CLG-24V4J42149	3/N/PE 400V 50/60Hz	IEC 60309, 16A 5-Pin 6Hr Red	12/12 ²
CLG-24V4K425A9	3/N/PE 400V 50/60Hz	IEC 60309, 32A 5-Pin 6Hr Red	12/12 ²

¹ Input cord selected at time of purchase

² qty x IEC 60320 C13 / qty x IEC 60320 C19

Power Ratings

Domestic Models

Part Number		Input	Output			
Master	Expansion	Rating: North America	Output Rating: North America	Outlet: North America	Branch: North America	Phase: North America
CSG-24V2A415A1	CLG-24V2A415A1	208-240V, 50/60Hz; 16A	208-240V, 50/60Hz; ≤ 16A	6xC19 ≤ 16A each, 18xC13 ≤ 12A each		
CSG-24V2C415A1	CLG-24V2C415A1	208-240V, 50/60Hz; 24A	208-240V, 50/60Hz; ≤ 24A	6xC19 ≤ 16A each, 18xC13 ≤ 12A each		
CSG-24VDD415A1	CLG-24VDD415A1	240V 3W+PE, 50/60Hz; 16A	240V, 50/60Hz; ≤ 27.6A	6x C19 ≤ 9.2A, 18x C13 ≤ 9.2A	XY, YZ, XZ ≤ 9.2A	XY, YZ, XZ ≤ 9.2A
CSG-24VDE415A1	CLG-24VDE415A1	240V 3W+PE, 50/60Hz; 24A	240V, 50/60Hz; ≤ 41.6A	6x C19 ≤ 13.9A, 18x C13 ≤ 12A	XY, YZ, XZ ≤ 13.9A	XY, YZ, XZ ≤ 13.9A
CSG-24VYL415A1	CLG-24VYL415A1	120/208V 3W+N+PE, 50/60Hz; 16A	208V, 50/60Hz; ≤ 27.6A	6x C19 ≤ 9.2A, 18x C13 ≤ 9.2A	XY, YZ, XZ ≤ 9.2A	XY, YZ, XZ ≤ 9.2A
CSG-24VYM411A1	CLG-24VYM411A1	120/208V 3W+N+PE, 50/60Hz; 24A	208V, 50/60Hz; ≤ 41.6A	6x C19 ≤ 13.9A, 18x C13 ≤ 12A	XY, YZ, XZ ≤ 13.9A	XY, YZ, XZ ≤ 13.9A
CSG-24VXD415A9	CLG-24VXD415A9	240V 3W+PE, 50/60Hz; 48A	240V, 50/60Hz; ≤ 83.1A	12xC19 ≤ 16A each, 12xC13 ≤ 12A each	XY1, XY2, YZ1, YZ2 ,ZX1, ZX2 ≤ 20A	XY, YZ, ZX ≤ 27.7A
CSG-24VDV415A9	CLG-24VDV415A9	240V 3W+PE, 50/60Hz; 40A	240V, 50/60Hz; ≤ 69.3A	12xC19 ≤ 16A each, 12xC13 ≤ 12A each	XY1, XY2, YZ1, YZ2 ,ZX1, ZX2 ≤ 20A	XY, YZ, ZX ≤ 23.1A
CSG-24VYY411A9	CLG-24VYY411A9	120/208V 3W+N+PE, 50/60Hz; 48A	208V, 50/60Hz; ≤ 83.1A	12xC19 ≤ 16A each, 12xC13 ≤ 12A each	XY1, XY2, YZ1, YZ2 ,ZX1, ZX2 ≤ 20A	XY, YZ, ZX ≤ 27.7A
CSG-24V53421A9	CLG-24V53421A9	240/415V 3W+N+PE, 50/60Hz; 16A	240V, 50/60Hz; ≤ 48A	12xC19 ≤ 16A each, 12xC13 ≤ 12A each	L1a, L1b, L2a, L2b, L3a, L3b ≤ 20A	L1, L2, L3 ≤ 16A
CSG-24V54421A9	CLG-24V54421A9	240/415V 3W+N+PE, 50/60Hz; 24A	240V, 50/60Hz; ≤ 72A	12xC19 ≤ 16A each, 12xC13 ≤ 12A each	L1a, L1b, L2a, L2b, L3a, L3b ≤ 20A	L1, L2, L3 ≤ 24A
CSG-24V5Z421A9	CLG-24V5Z421A9	240/415V 3W+N+PE, 50/60Hz; 24A	240V, 50/60Hz; ≤ 72A	12xC19 ≤ 16A each, 12xC13 ≤ 12A each	L1a, L1b, L2a, L2b, L3a, L3b ≤ 20A	L1, L2, L3 ≤ 24A

International Models

Part Number		Input	Output			
Master	Expansion	Rating: International	Output Rating: International	Outlet: International	Branch: International	Phase: International
CSG-24VEA415A1	CLG-24VEA415A1	230V, 50/60Hz; 16A	230V, 50/60Hz; ≤ 16A	6xC19 ≤ 16A each, 18xC13 ≤ 10A each		
CSG-24VEK415A1	CLG-24VEK415A1	230V, 50/60Hz; 32A	230V, 50/60Hz; ≤ 32A	6xC19 ≤ 16A each, 18xC13 ≤ 10A each		
CSG-24V4J421A9	CLG-24V4J421A9	230/400V 3W+N+PE, 50/60Hz; 16A	230V, 50/60Hz; ≤ 48A	12xC19 ≤ 16A each, 12xC13 ≤ 10A each	L1a, L1b, L2a, L2b, L3a, L3b ≤ 16A	L1, L2, L3 ≤ 16A
CSG-24V4K425A9	CLG-24V4K425A9	230/400V 3W+N+PE, 50/60Hz; 32A	230V, 50/60Hz; ≤ 96A	12xC19 ≤ 16A each, 12xC13 ≤ 10A each	L1a, L1b, L2a, L2b, L3a, L3b ≤ 16A	L1, L2, L3 ≤ 32A

Physical Specifications

Operating		Storage
Temperature	32° to 122° F (0° to 50° C)	-40° to 185° F (-40° to 85° C)
Elevation (above MSL)	0 to 10,000 ft (0 to 3000m)	0 to 50,000 ft (0 to 15000m)
Relative Humidity	8 to 90%, non-condensing	8 to 90%, non-condensing
Dimensions (H x W x D)		Weight
CxG-24V2x415A1	61.0 x 1.75 x 3.50 in. (1550 x 44 x 89 mm)	22.3 lbs (10.1 kg)
CxG-24VEx415A1	61.0 x 1.75 x 3.50 in. (1550 x 44 x 89 mm)	22.3 lbs (10.1 kg)
CxG-24VDx415A1	69.0 x 1.75 x 3.50 in. (1753 x 44 x 89 mm)	25.6 lbs (11.6 kg)
CxG-24VYx415A1	69.0 x 1.75 x 3.50 in. (1753 x 44 x 89 mm)	25.6 lbs (11.6 kg)
CxG-24VDx415A9	74.8 x 1.75 x 3.50 in. (1899 x 44 x 89 mm)	34.6 lbs (15.7 kg)
CxG-24VYx411A9	74.8 x 1.75 x 3.50 in. (1899 x 44 x 89 mm)	35.1 lbs (15.9 kg)
CxG-24V4x421A9	70.6 x 1.75 x 3.50 in. (1794 x 44 x 89 mm)	31.0 lbs (14.1 kg)
CxG-24V5x421A9	70.6 x 1.75 x 3.50 in. (1794 x 44 x 89 mm)	31.0 lbs (14.1 kg)

Branch Circuit Protection



**Always disconnect ALL power supply cords before opening to avoid electrical shock.
Afin d'éviter les chocs électriques, débranchez TOUTES les câbles électrique avant d'ouvrir.
Vor dem Öffnen immer Netzleitungen abziehen um elektrischen Schlag zu vermeiden.**

Server Technology CDUs feature Branch Circuit protection in the form of internal fuses, retractable fuse holders, and circuit breakers. These fuses and circuit breakers must meet the strict safety requirements of UL/CSA 60950 and EN-60950 for Branch Circuit Protection.

Fuses that are accessible through fuse access windows or the retractable fuse holders are user-replaceable once the input feed has been disconnected. Circuit breakers may be reset once the fault has been identified and corrected. There are no serviceable parts inside the CDU. Please contact Server Technology for technical support or service.

Time-Delay Fuses – Class G

Amperes	Bussman Part Number
20	SC-20

CooperBussman product data-sheet #1024

Data Connections

RS-232 port

Smart POPS CDUs are equipped standard with an RJ45 DTE RS-232c serial port. This connector may be used for direct local access or from other serial devices such as a terminal server. An RJ45 crossover cable is provided for connection to an RJ45 DCE serial port.

Pin	DTE Signal Name		Input/Output
1	Request to Send	RTS	Output
2	Data Terminal Ready	DTR	Output
3	Transmit Data	TD	Output
4	Signal Ground		
5	Signal Ground		
6	Receive Data	RD	Input
7	Data Set Ready	DSR	Input
8	Clear to Send	CTS	Input

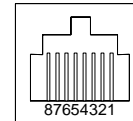

RJ45 to DB9F serial port adapter

An RJ45 to DB9F serial port adapter is provided in conjunction with the RJ45 crossover cable to connect to a PC DB9M DCE serial port. The adapter pinouts below reflect use of the adapter with the provided RJ45 crossover cable.

Pin	DCE Signal Name		Input/Output
1			
2	Receive Data	RD	Output
3	Transmit Data	TD	Input
4	Data Terminal Ready	DTR	Input
5	Signal Ground		
6	Data Set Ready	DSR	Output
7	Request to Send	RTS	Input
8	Clear to Send	CTS	Output

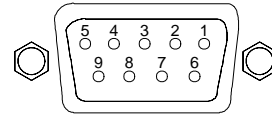

Regulatory Compliance

Product Safety

Units have been safety tested and certified to the following standards:

- USA/Canada UL 60950:2003 and CAN/CSA 22.2 No. 60950-1-03
- European Union EN60950-1:2001

This product is also designed for Norwegian IT power system with phase-to phase voltage 230V.

USA Notification

Note: This equipment has been tested and found to comply with the limits for a Class A digital device, pursuant to part 15 of the FCC Rules. These limits are designed to provide reasonable protection against harmful interference when the equipment is operated in a commercial environment. This equipment generates, uses, and can radiate radio frequency energy and, if not installed and used in accordance with the instruction manual, may cause harmful interference to radio communications. Operation of this equipment in a residential area is likely to cause harmful interference in which case the user will be required to correct the interference at the user's own expense.

Modifications not expressly approved by the manufacturer could void the user's authority to operated the equipment under FCC rules.

Canadian Notification

This Class A digital apparatus complies meets all requirements of the Canadian Interference-Causing Equipment Regulations.

Cet appareil numérique de la classe A respecte toutes les exigences du Règlement sur le matériel brouilleur du Canada.

European Union Notification

Products with the CE Marking comply with both the EMC Directive (89/336/EEC) and the Low Voltage Directive (73/23/EEC) issued by the Commission of the European Community.

Compliance with these directives implies conformity to the following European Norms:

- EN55022 Electromagnetic Interference
- EN55024 Electromagnetic Immunity
- EN60950-1 Product Safety
- EN61000-3 Harmonics and Flicker



Products with the following mark comply with the RoHS Directive (2002/95/EC) issued by the Commission of the European Community.

Japanese Notification

この装置は、情報処理装置等電波障害自主規制協議会（VCCI）の基準に基づくクラスA情報技術装置です。この装置を家庭環境で使用すると電波妨害を引き起こすことがあります。この場合には使用者が適切な対策を講ずるよう要求されることがあります。

本製品に同梱または付属しております電源コードは、本製品専用です。本製品以外の製品ならびに他の用途に使用しないで下さい。

Chinese Notification

关于符合中国《电子信息产品污染控制管理办法》的声明

产品中有毒有害物质的名称及含量

部件名称 (Parts)	有毒有害物质或元素 (Hazardous Substance)					
	铅 (Pb)	汞 (Hg)	镉 (Cd)	六价铬 (Cr (VI))	多溴联苯 (PBB)	多溴二苯醚 (PBDE)
机箱子组件 (Chassis Subassembly)	O	O	O	O	O	O
印刷板组件 (PCAs)	X	O	O	O	O	O

O 表示该有毒有害物质在该部件所有均质材料中的含量均在SJ/T 11363-2006 标准规定的限量要求以下。
Indicates that this hazardous substance contained in all homogeneous materials of this part is below the limit requirement in SJ/T 11363-2006.

X 表示该有毒有害物质至少在该部件的某一均质材料中的含量超出SJ/T 11363-2006 标准规定的限量要求。
Indicates that this hazardous substance contained in at least one of the homogeneous materials of this part is above the limit requirement in SJ/T 11363-2006.

Recycling



Server Technology Inc. encourages the recycling of its products. Disposal facilities, environmental conditions and regulations vary across local, state and country jurisdictions, so Server Technology encourages consultation with qualified professional and applicable regulations and authorities within your region to ensure proper disposal.

Waste Electrical and Electronic Equipment (WEEE)



In the European Union, this label indicates that this product should not be disposed of with household waste. It should be deposited at an appropriate facility to enable recovery and recycling.

For information on how to recycle this product responsibly in your country, please visit:
www.servertech.com/support/recycling.

Appendix D: Warranty, Product Registration and Support

Warranty

For the Server Technology warranty information, please see our website at www.servertech.com

Product Registration

Registration is your key to special offers and services reserved for registered users.

- Excellent Technical Support Services
- Special Update and Upgrade Programs
- Warranty Protection
- Extended Warranty Service
- New Product Information

Register your products at www.servertech.com

Technical Support



Experience Server Technology's FREE SMARTER Technical Support

Server Technology understands that there are often questions when installing and/or using a new product. Free Technical Support is provided from 8 a.m. to 5 p.m. PST, Monday through Friday. After-hours service is provided to ensure your requests are handled quickly no matter what time zone or country you are located in.

Server Technology, Inc

1040 Sandhill Drive

Tel: 775.284.2000

Web: www.servertech.com

Reno, Nevada 89521 USA

Fax: 775.284.2065

Email: support@servertech.com

Return Merchandise Authorization

If you have a unit that is not functioning properly and is in need of technical assistance or repair, please review Server Technology's **Return Merchandise Authorization** process on our website at www.servertech.com



Server Technology

HEADQUARTERS – NORTH AMERICA

Server Technology, Inc.
1040 Sandhill Drive
Reno, NV 89521
United States
+1.775.284.2000 Tel
+1.775.284.2065 Fax
sales@servertech.com
www.servertech.com
www.servertechblog.com

EMEA

Server Technology Intl
Sienna Court
The Broadway
Maidenhead
Berkshire
SL6 1NJ
United Kingdom
+44 (0) 1628 509053 Tel
+44 (0) 1628 509100 Fax
salesintl@servertech.com

APAC

Server Technology, Inc.
Singapore
+65 (0) 6829 7008 Tel
+65 (0) 6234 4574 Fax
salesintl@servertech.com